

**OceanStor 2200 V3  
V300R006**

# **Product Description**

**Issue** 09  
**Date** 2019-05-15



**Copyright © Huawei Technologies Co., Ltd. 2019. All rights reserved.**

No part of this document may be reproduced or transmitted in any form or by any means without prior written consent of Huawei Technologies Co., Ltd.

## **Trademarks and Permissions**



HUAWEI and other Huawei trademarks are trademarks of Huawei Technologies Co., Ltd.

All other trademarks and trade names mentioned in this document are the property of their respective holders.

## **Notice**

The purchased products, services and features are stipulated by the contract made between Huawei and the customer. All or part of the products, services and features described in this document may not be within the purchase scope or the usage scope. Unless otherwise specified in the contract, all statements, information, and recommendations in this document are provided "AS IS" without warranties, guarantees or representations of any kind, either express or implied.

The information in this document is subject to change without notice. Every effort has been made in the preparation of this document to ensure accuracy of the contents, but all statements, information, and recommendations in this document do not constitute a warranty of any kind, express or implied.

## **Huawei Technologies Co., Ltd.**

Address: Huawei Industrial Base  
Bantian, Longgang  
Shenzhen 518129  
People's Republic of China

Website: <http://e.huawei.com>

# About This Document

## Purpose





This document describes the orientation, features, architecture, technical specifications, product configuration, environment requirements, standards compliance and granted certifications of the OceanStor 2200 V3 storage system.

## Intended Audience

This document is intended for: All readers

## Symbol Conventions

The symbols that may be found in this document are defined as follows.

Symbol	Description
	Indicates an imminently hazardous situation which, if not avoided, will result in death or serious injury.
	Indicates a potentially hazardous situation which, if not avoided, could result in death or serious injury.
	Indicates a potentially hazardous situation which, if not avoided, may result in minor or moderate injury.
	Indicates a potentially hazardous situation which, if not avoided, could result in equipment damage, data loss, performance deterioration, or unanticipated results. NOTICE is used to address practices not related to personal injury.
	Calls attention to important information, best practices and tips. NOTE is used to address information not related to personal injury, equipment damage, and environment deterioration.

## Change History

Changes between document issues are cumulative. The latest document issue contains all the changes made in earlier issues.

### Issue 09 (2019-05-15)

This issue is the ninth official release.

- Added the feature of SmartMigration for file services.
- Updated specifications.

### Issue 08 (2018-12-06)

This issue is the eighth official release. The updates are as follows:

Made minor changes in specifications.

### Issue 07 (2018-07-30)

This issue is the seventh official release. The updates are as follows:

Made minor changes in specifications.

### Issue 06 (2018-05-09)

This issue is the sixth official release. The updates are as follows:

Made minor changes in specifications.

### Issue 05 (2018-01-30)

This issue is the fifth official release. The updates are as follows:

Made minor changes in specifications.

### Issue 04 (2017-11-30)

This issue is the fourth official release. The updates are as follows:

Made minor changes in specifications.

### Issue 03 (2017-08-30)

This issue is the third official release. The updates are as follows:

Made some changes in specifications.

### Issue 02 (2017-06-01)

This issue is the second official release. The updates are as follows:

Made minor changes in specifications.

### **Issue 01 (2017-02-28)**

This issue is the first official release.

---

# Contents

---

<b>About This Document.....</b>	<b>ii</b>
<b>1 Product Positioning.....</b>	<b>1</b>
<b>2 Product Features.....</b>	<b>4</b>
<b>3 Typical Applications.....</b>	<b>10</b>
3.1 High-Performance Applications.....	10
3.2 High-Availability Applications.....	12
3.3 High-Density and Multi-Service Applications.....	14
<b>4 Hardware Architecture.....</b>	<b>17</b>
4.1 Device Composition.....	17
4.2 2 U Controller Enclosure.....	18
4.2.1 Overview.....	18
4.2.2 Component Description.....	22
4.2.2.1 System Subrack.....	22
4.2.2.2 Controller.....	23
4.2.2.3 Power Module.....	27
4.2.2.4 Disk Module.....	28
4.2.2.5 GE Electrical Interface Module.....	30
4.2.2.6 10GE Electrical Interface Module.....	31
4.2.2.7 8 Gbit/s Fibre Channel Interface Module (Eight Ports).....	33
4.2.2.8 SmartIO Interface Module (Two Ports).....	34
4.2.2.9 SmartIO Interface Module (Four Ports).....	36
4.2.3 Indicator Introduction.....	38
4.3 2 U Disk Enclosure (2.5-Inch Disks).....	44
4.3.1 Overview.....	44
4.3.2 Component Description.....	45
4.3.2.1 System Subrack.....	46
4.3.2.2 Expansion Module.....	46
4.3.2.3 Power Module.....	48
4.3.2.4 Disk Module.....	50
4.3.3 Indicator Introduction.....	51
4.4 4 U Disk Enclosure (3.5-Inch Disks).....	53
4.4.1 Overview.....	54

4.4.2 Component Description.....	56
4.4.2.1 System Subrack.....	56
4.4.2.2 Expansion Module.....	57
4.4.2.3 Power Module.....	58
4.4.2.4 Fan Module.....	60
4.4.2.5 Disk Module.....	61
4.4.3 Indicator Introduction.....	62
4.5 Coffer Disk.....	65
4.6 Device Cables.....	68
4.6.1 Power Cables.....	68
4.6.2 Ground Cables.....	69
4.6.3 Network Cables.....	69
4.6.4 Serial Cables.....	70
4.6.5 Mini SAS HD Cables.....	70
4.6.5.1 Mini SAS HD Electrical Cables.....	71
4.6.5.2 Mini SAS HD Optical Cables.....	71
4.6.6 Optical Fibers.....	72
<b>5 Software Architecture.....</b>	<b>74</b>
<b>6 Product Specifications.....</b>	<b>80</b>
6.1 Hardware Specifications.....	80
6.2 Software Specifications.....	86
<b>7 Environmental Requirements.....</b>	<b>98</b>
7.1 Temperature, Humidity, and Altitude.....	98
7.2 Vibration and Shock.....	99
7.3 Particle Contaminants.....	100
7.4 Corrosive Airborne Contaminants.....	101
7.5 Heat Dissipation and Noise.....	103
<b>8 Standards Compliance.....</b>	<b>106</b>
<b>9 Certifications.....</b>	<b>110</b>
<b>10 Operation and Maintenance.....</b>	<b>114</b>
<b>A How to Obtain Help.....</b>	<b>116</b>
A.1 Preparations for Contacting Huawei.....	116
A.1.1 Collecting Troubleshooting Information.....	116
A.1.2 Making Debugging Preparations.....	116
A.2 How to Use the Document.....	116
A.3 How to Obtain Help from Website.....	117
A.4 Ways to Contact Huawei.....	117
<b>B Glossary.....</b>	<b>118</b>

---

**C Acronyms and Abbreviations..... 119**



---

# 1 Product Positioning

---

The OceanStor 2200 V3 storage system is a Huawei next-generation storage product designed for midtier-to-enterprise storage environments. It provides mass data storage, fast data access, and high utilization in the ease-of-use and energy saving form factor.

The OceanStor 2200 V3 storage system offers comprehensive and superb solutions by unifying file-based, block-based offerings and various protocols into a single product and using diverse efficiency boost mechanisms to provide industry-leading performance. Those solutions help customers maximize their return on investment (ROI) and are designed for a wide range of environments such as Online Transaction Processing (OLTP) and Online Analytical Processing (OLAP) of large databases, high-performance computing (HPC), digital media, Internet operation, centralized storage, backup, disaster recovery, and data migration.

In addition to providing high-performance storage services for application servers, the OceanStor 2200 V3 storage system supports advanced data backup and disaster recovery technologies, ensuring the secure and smooth running of data services. Also, the OceanStor 2200 V3 storage system offers easy-to-use management modes and convenient local/remote maintenance modes, greatly decreasing the management and maintenance costs.

## OceanStor 2200 V3 (8 GB Memory per Controller) on a SAN Network

**Figure 1-1** shows the position and application of the OceanStor 2200 V3 (8 GB memory per controller) on a SAN network.

Figure 1-1 Position and application

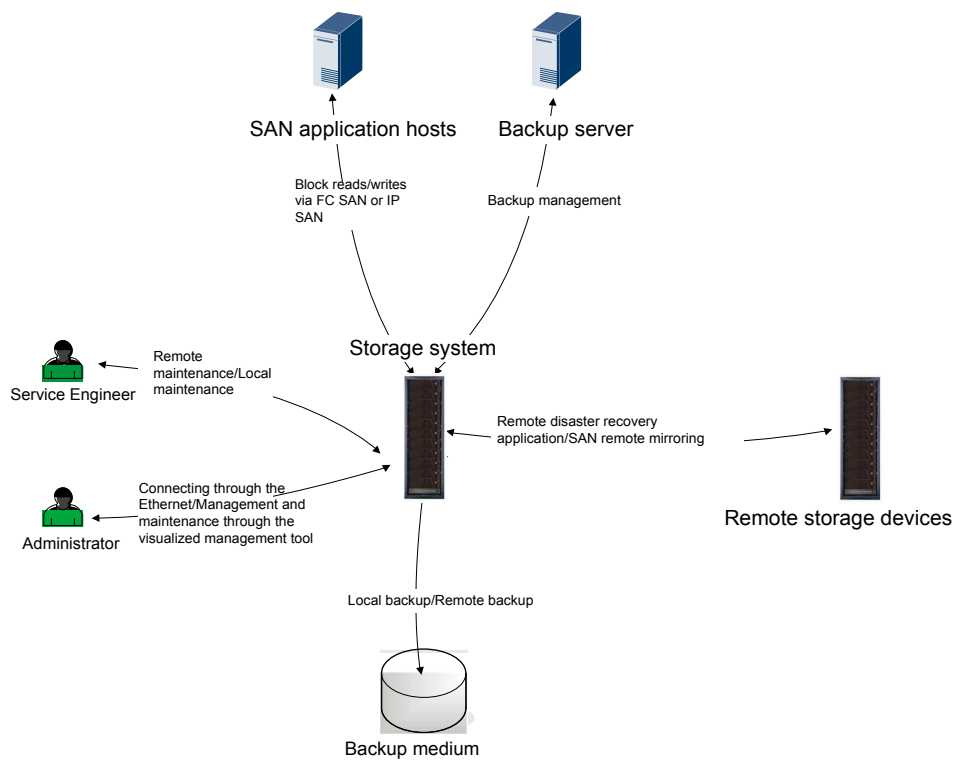

## OceanStor 2200 V3 (16 GB Memory per Controller) on a NAS&SAN Network

Figure 1-2 shows the position and application of the OceanStor 2200 V3 (16 GB memory per controller) on a unified SAN and NAS network.

Figure 1-2 Position and application

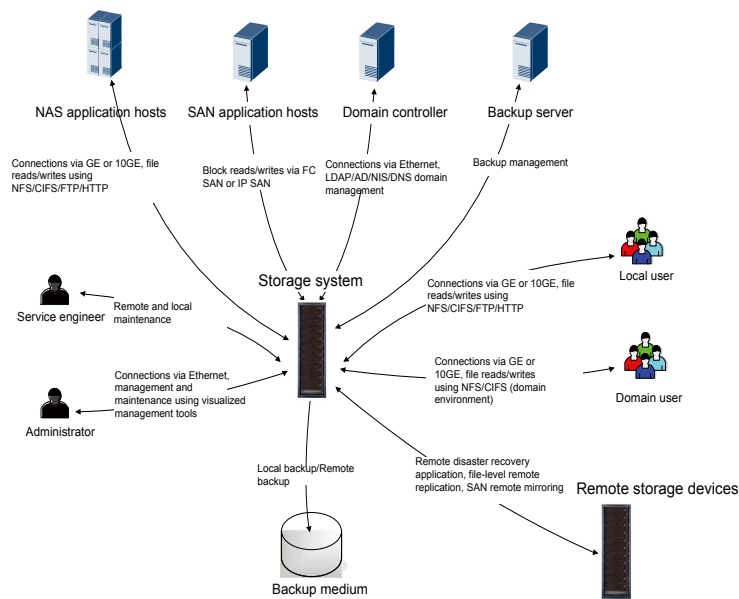

# 2 Product Features

---

Designed for midtier-to-enterprise storage environments, the OceanStor 2200 V3 storage system utilizes high-specification hardware. It offers significant advancements in data applications and protection and provides the following benefits:

## High Performance

The OceanStor 2200 V3 storage system offers a three-level performance acceleration technology, and delivers hierarchical performance for different applications. The three levels are:

1. State-of-the-art hardware

The OceanStor 2200 V3 storage system is equipped with multi-core processors, high-speed and large-capacity caches, and various high-speed interface modules. The superior hardware allows it to offer better storage performance than tradition storage systems.

2. SmartTier

The SmartTier technology identifies hotspot data and periodically promotes it to high-performance storage medium for a performance boost. In addition, SmartTier supports solid state drive (SSD) data caching, accelerating access to hotspot data.

3. SSDs

The OceanStor 2200 V3 storage system can be fully configured with SSDs to provide peak performance for the most-demanding applications.

## Flexible Scalability

The OceanStor 2200 V3 storage system has an outstanding scalability. It supports a wide range of the following disks and host interface modules in a high density:

- Disks:  
SAS disks, NL-SAS disks, and SSDs.
- Host interface modules:  
GE, 10GE, and SmartIO.

 **NOTE**

SmartIO interface modules support various port types including 8 Gbit/s Fibre Channel, 16 Gbit/s Fibre Channel, 10 Gbit/s FCoE (VN2VF), 10 Gbit/s Ethernet, and iWARP (interconnection between Scale-out nodes).

## Proven Reliability

The OceanStor 2200 V3 storage system uses advanced technologies to offer protection measures, minimizing risks of failures and data loss.

- Protection against component failures  
The storage system components are in 1+1 redundancy and work in active-active mode. Normally, every two components work simultaneously and share loads. If one component fails or goes offline, the other one takes over all loads and speeds up to compensate. The whole process is transparent to applications.
- RAID 2.0+ underlying virtualization  
The storage system employs innovative RAID 2.0+ underlying virtualization technology for automatic load balancing. If a disk encounters a fault, all the other disks in the same disk domain help construct the faulty disk's service data, achieving a 20-fold faster reconstruction speed than traditional RAID technology. In addition, RAID 2.0+ significantly reduces the possibility of multi-disk failure.
- Data protection in the event of a controller failure
  - Built-in backup power modules supply power to controller enclosures in the event of unexpected power failures. They enable cache data to be written to built-in disks of controllers to avoid data loss.
  - When a piece of software is faulty, the storage system will attempt to reboot. During the reboot, data is stored in the cache. If the reboot fails, data in the cache will be written into the built-in disks of controllers to avoid data loss.
  - If hardware of a controller is faulty, the storage system will use the memory mirroring technology to enable the other normal controller to take over the services to ensure data consistency.
- Bad sector repair  
In a storage system, the frequently occurred fault is bad sectors of disks. The OceanStor 2200 V3 storage system adopts the bad sector repair technology to proactively detect and repair bad sectors, reduce the disk failure rate by 50%, and prolong the service life of disks.
- Disk pre-copy  
The disk pre-copy technology enables the storage system to routinely check the hardware status. Once it detects that a disk has fault risks, it will enable data migration from the disk to another normal disk to prevent data loss.
- IP failover  
The storage system adopts IP failover technology. If a physical host port that implements the NAS protocol is damaged, the IP address assigned to that port automatically fails over to another functional port. Based on the correct networking, services are seamlessly failed over, preventing damage to a port from affecting services.
- Online disk diagnosis  
The online disk diagnosis feature is used to handle disk faults. If a disk fault occurs, the storage system takes the disk offline. Then, the online diagnosis module reads the S.M.A.R.T information about the disk and takes analysis, testing, and recovery measures. After the disk is recovered, the online diagnosis module enables the disk to rejoin the RAID, prolonging the lifecycle of the disk.
- Data coffer disk  
Data coffer disks consist of the first four disks of a storage system's controller enclosure as well as each controller's built-in disk. They store three types of data: cache data

requiring power failure protection, OceanStor OS system data, and system configuration information and logs.

## High Availability

In routine maintenance:

The OceanStor 2200 V3 storage system uses Turbo Module, online capacity expansion, and disk roaming technologies to provide high availability for applications and nonstop system running during maintenance.

- Turbo Module enables controllers, fans, power modules, interface modules, and disks to be hot-swappable, allowing online operations.
- Dynamic capacity expansion enables users to add disks to a disk domain in an online and easy manner.
- Disk roaming enables a storage system to automatically identify relocated disks and resume their services.

Cloud-based operation and maintenance (eService, also called as the Call Home service that is applicable to V300R006C10 and later versions)

Huawei provides the eService service to remotely connect OceanStor 2200 V3 storage system to the eService cloud platform, enabling centralized, remote, and intelligent operation and maintenance of storage devices. The Big Data analytics technology is used to prevent faults and locate faults quickly. In addition, it provides the optimal configuration, performance optimization suggestions, and troubleshooting solutions based on user service characteristics.

In data protection:

The OceanStor 2200 V3 storage system provides the following advanced data protection technologies and protocols to protect data integrity and continuous system running even when catastrophic disasters happen:

- Snapshot generates multiple point-in-time images for the source logical unit number (LUN) or source file system data. The snapshot images can be used to recover data quickly when needed.
- LUN copy backs up data among heterogeneous storage systems for data protection.
- Remote replication backs up local data onto a remote storage system for disaster recovery.
- Clone preserves a real-time physical copy of a source LUN for the high availability of local data.
- HyperMirror backs up data in real time. If the source data becomes unavailable, applications can automatically use the data copy, ensuring data security and business continuity.

In resource management:

The OceanStor 2200 V3 storage system employs the following resource application technologies and provides flexible resource management to protect customers' storage investments:

- SmartVirtualization enables a local storage system to centrally manage storage resources of heterogeneous storage systems, simplifying storage system management and reducing maintenance costs.

- SmartMigration migrates LUNs in or between storage systems, adjusting and allocating resources along with business development.

The OceanStor 2200 V3 storage system supports memory upgrade so that storage performance matches service development.

## High System Security

Storage network security:

- Security of management channels  
The management operations from physical ports are controlled by the access authentication mechanism of the storage system, and only authorized users are allowed to manage the storage system.
- Anti-attack protection for protocols and ports  
The storage system provides only necessary ports to the external for system operations and maintenance. All the ports used are listed in the *Communication Matrix*. Dynamic listening ports are functioning in the proper scope, and no undisclosed interface exists.
- Service ports are isolated from management ports  
The Access Control List (ACL) mechanism is adopted to isolate Ethernet ports from internal heartbeat network ports, management network ports, and maintenance network ports.

Storage service security:

- Security of the operating system  
The storage system uses a dedicated operating system. Security of the operating system has been hardened before the storage system is delivered. The storage systems update security patches for their operating systems and open-source software based on site requirements, safeguarding users' data.
- Data storage encryption
  - The storage system supports data encryption by using a network password manager. The network password manager employs the standard cryptographic algorithm supported by the State Encryption Administration of China. It allows only the hosts that comply with security policies to access storage system data by auditing access control policies and controlling access attempts from hosts. After the network password manager is deployed, all mutual information between the hosts and storage system will pass the network password manager to enable read/write data encryption and decryption. This ensures data security of the storage system.
  - The storage system supports disk encryption. The hardware circuits and internal data encrypt key of disks are used for data writing encryption and data reading decryption. To ensure the security of data encrypt key, the storage system and the third-party key management server jointly provide a highly secure, reliable, and available key management solution.
- Data destruction  
When deleting unwanted data, the system erases the specified LUN to make the deleted data unable to be restored, preventing critical data leaks.

Storage management security:

The operations of users can be allowed and denied. All management operations are logged by the system.

## Virtualization, Intelligence, and Efficiency

The OceanStor 2200 V3 storage system absorbs the concept of "Virtualization, Intelligence, and Efficiency", which fits the up-to-date storage design idea and wins a leading position for the storage system. Compared with traditional storage systems, the storage system introduces the following technologies to provide higher storage space usage, faster data reconstruction, smarter performance allocation, and finer service quality control:

- **RAID 2.0+ underlying virtualization**  
Divides disk storage space into small-sized data blocks and uses the blocks to create RAID groups for fine-grained resource management. The technology realizes automatic load balancing, higher storage performance, better storage space utilization, faster disk reconstruction, and finer storage space management. RAID 2.0+ serves as a basis for a number of other advanced storage technologies.
- **SmartTier (intelligent storage tiering)**  
Enables a storage system to automatically analyze data access frequency per unit time and relocate data to disks of different performance levels based on the analysis result. High-performance disks store hot data, performance disks store warm data, and large-capacity disks store cold data. As a result, SmartTier optimizes overall performance and reduces costs per IOPS.
- **SmartQoS (intelligent service quality control)**  
Enables a storage system to categorize service data based on data characteristics (each category represents a type of application) and set a priority and performance objective for each category. In this way, resources are assigned to services based on priorities, ensuring the performance of mission-critical services that have the top priority.
- **SmartThin (intelligent thin provisioning)**  
Allows on-demand allocation of storage space rather than the traditional method of pre-allocating all storage space at the initial stage. It is more efficient because the amount of resources used is close to the amount of resources allocated. In this way, the initial purchase cost and total cost of ownership are reduced.
- **SmartCache (intelligent storage cache)**  
Uses SSDs as cache resources to significantly promote system read performance when random, small I/Os with hot data require more read operations than write operations.
- **Quick document incremental backup with Tivoli Storage Manager (TSM)**  
When the storage system interworks with the TSM backup software to perform incremental file backup, the Snapdiff feature uses the snapshot mechanism to quickly obtain differential file information and identify changed files. Without the need for full scanning, only changed files are backed, greatly shortening backup time. The backup performance is not affected by the number of files, which greatly improves the backup efficiency.

## Cost-Effectiveness and Ease-of-Use

The OceanStor 2200 V3 storage system delivers cost-effective performance through intelligent CPU frequency control and delicate fan speed control. It also provides a series of management and maintenance tools for easy use and maintenance.

- **Cost-effectiveness**
  - Intelligent CPU frequency control



- Automatically changes the CPU frequency based on the system loads. It decreases the CPU frequency and power consumption during off-peak hours for a low operation cost and long CPU service life.
- Delicate fan speed control  

Dynamically adjusts the fan speed based on the storage system's temperature. It lowers the noise and power consumption and cuts the operation cost.
- Ease-of-use
  - DeviceManager  

A tool based on the graphical user interface (GUI) allows you to easily manage storage systems through wizard-instructed operations.
  - Storage resource configuration tool: SmartConfig  

Installed on application servers, SmartConfig is a piece of software providing easy management of storage systems. With this tool, only three steps are needed to easily, flexibly, and effectively divide storage resources into disks and mount them to servers.
  - Integrated management  

Implements convenient device management by integrating a management plug-in into mainstream management software such as VMware vCenter plug-in, Hyper-V System Center, vSphere API for Storage Awareness (VASA), vSphere Storage APIs for Array Integration (VAAI), and Volume Shadow Copy Service (VSS) Provider.
  - Tablet management  

Supports flexible storage system management on a tablet.
  - Various alarm notification methods  

Provides alarm notification by sound, indicator, short message service (SMS), or email.
  - Tool for an upgrade at your fingertip  

Provides one-click online upgrade for controllers. The operation is easy without interrupting services.

# 3 Typical Applications

---

## About This Chapter

The OceanStor 2200 V3 storage system offers industry-leading hardware specifications, a flexible and reliable hardware design, a virtualized underlying architecture, and advanced data protection technologies, addressing the needs of differentiated storage applications. The storage system is designed for a wide range of applications including high-performance, high-availability, or multi-service applications.

[3.1 High-Performance Applications](#)

[3.2 High-Availability Applications](#)

[3.3 High-Density and Multi-Service Applications](#)

## 3.1 High-Performance Applications

The OceanStor 2200 V3 storage system incorporates various technologies to boost the system performance. Its high-performance hardware delivers outstanding data access performance. The virtualization technology can improve the storage performance continuously and it shatters performance bottlenecks from future business growth. The intelligent data tiering technology SmartTier automatically detects and prioritizes hotspot data. Therefore, the OceanStor 2200 V3 storage system is a great choice for the high-performance applications.

### On-Demand System Performance Boost

In certain scenarios, a storage system may have been provisioned to meet the initial application requirements. However, the future growth of applications often exceeds expectation, and the performance of a traditional storage system will soon become a limiting factor. The virtualization technology of the OceanStor 2200 V3 storage system can address this issue. It dynamically increases storage performance based on current application requirements. This prolongs the system service life and lowers customers' total cost of ownership (TCO).

After the initial purchase, the storage system is equipped with affordable hard disk drives (HDDs) to deliver data storage services. As the service requirements increase and the storage system performance becomes insufficient, administrators can add HDDs of high speeds or SSDs to boost the system performance. If even greater system performance is required, administrators can replace all the existing HDDs with SSDs to further improve system performance.

This on-demand system performance boost brings the following benefits:

- The system performance is improved gradually, balancing the ROI and the system service life.
- Components for upgrade are available, following the Moore's Law to reduce the purchase cost and the TCO.

## Dynamic Storage Tiering for Hotspot Data

In media and website applications, information has a high access frequency, which will generate hotspot data. The hotspot data receives simultaneous read and write requests from a large number of servers, and poses a demanding requirement on storage system performance. Traditional storage systems cannot address such a storage requirement.

The OceanStor 2200 V3 storage system uses the intelligent data tiering technology, SmartTier, to identify hotspot data and promote it to high-performance SAS disks or SSDs. If SmartTier later finds out that the hotspot data becomes cold (receiving fewer access requests), it demotes the data to low-performance disks and clears storage space for new hotspot data. **Figure 3-1** depicts the working principle of SmartTier.

**Figure 3-1** SmartTier working principle

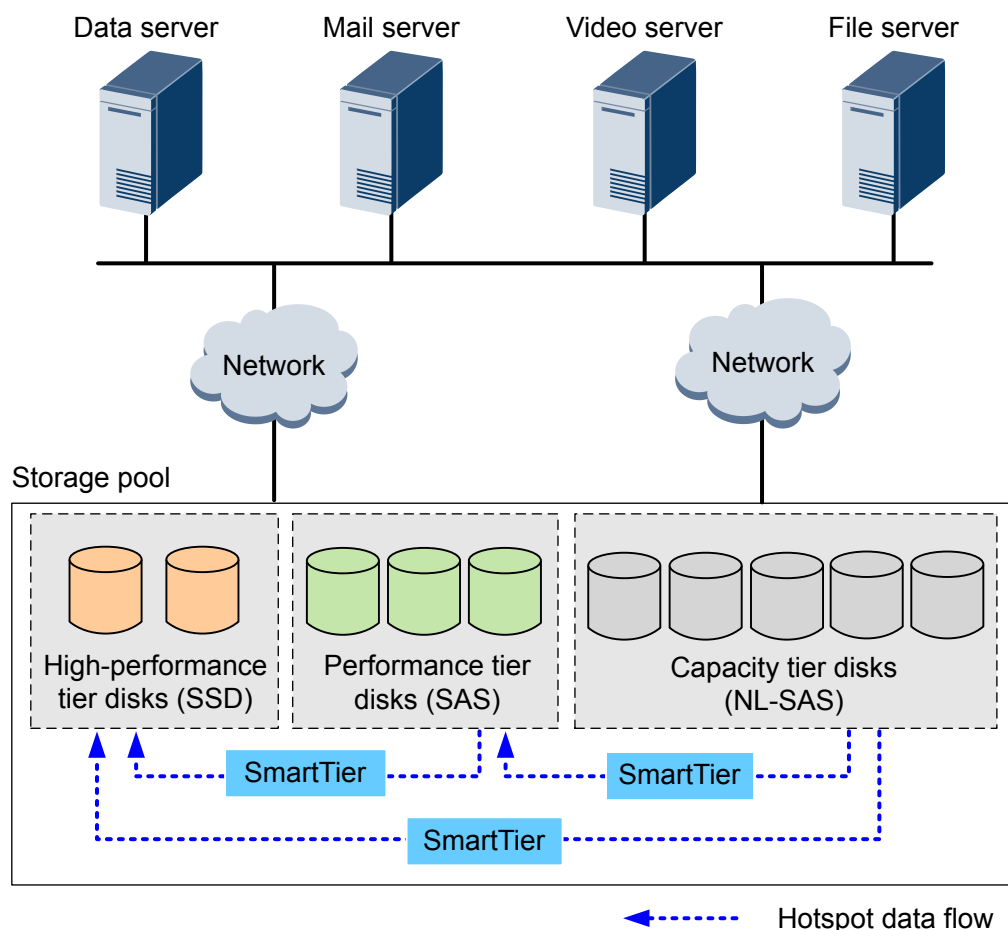

## 3.2 High-Availability Applications

The OceanStor 2200 V3 storage system has a highly reliable design, achieving a long mean time between failures (MTBF), and ensuring high availability of storage applications. It also incorporates a variety of data protection technologies, and protects data integrity and service continuity against catastrophic disasters.

### In-Service Routine Maintenance

In traditional storage systems, routine maintenance tasks, such as component replacement and capacity expansion, must be implemented in offline mode. The OceanStor 2200 V3 storage system, however, assembles advanced technologies for in-service routine maintenance:

- Turbo Module  
Enables online replacement of components and requires no system restart.
- Online capacity expansion  
Allows online addition of disks and expansion of storage pools.

### Tolerance of Single Points of Failures

The OceanStor 2200 V3 storage system incorporates a hierarchical redundancy design to eliminate the impact of single points of failure:

- Hardware redundancy  
All components of the storage system are in redundancy and work in active-active mode. If one component fails, the other speeds up to compensate so that the storage system can continue operating.
- Link redundancy  
If there is only one link between the storage system and an application server, the disconnection of the link terminates their communication in between. To eliminate this failure, the storage system uses two or more links to communicate with the application server. Therefore, if one link is down, the other links take over the services to continue the data transmission.
- Application server clustering  
If the storage system cooperates with only one application server, the failure of the application server interrupts services. Application server clustering can address this issue. A cluster consists of two or more application servers that share loads. If one application server in the cluster fails, the other application servers take over its loads, and the whole process is transparent to users. Application server clustering supported by the storage system ensures business continuity.

Based on the previous protection mechanisms, the storage system has proven tolerance of single points of failure, as shown in [Figure 3-2](#).

**Figure 3-2** Tolerance of single points of failure

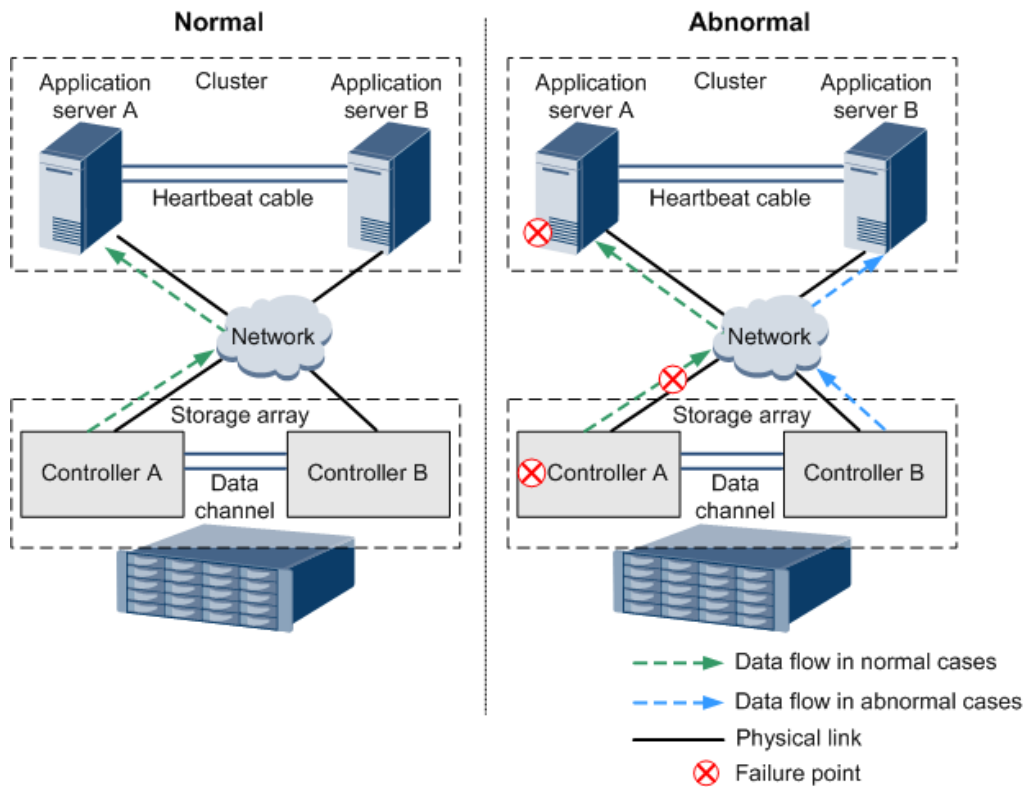

In the example in [Figure 3-2](#), application server A and controller A are faulty, so a link between the cluster and the storage system is down. Under this circumstance, the redundant components and links compensate for the failed ones. This ensures the nonstop system operations and greatly improves the service availability.

## Resilience Against Disasters

The OceanStor 2200 V3 storage system complements various data protection methods for backup and disaster recovery. Those methods eliminate the risks of unexpected downtime and data loss caused by natural disasters, serious device failures, or man-made misoperations.

The supported data protection methods include:

- Backup

The storage system processes a huge amount of data, and the loss of any data can lead to a disastrous result. Therefore, enterprises are used to periodically backing up their critical data. The following backup technologies are most commonly used because they complete data backup in a hitless manner:

- Snapshot: locally generates a virtual duplicate for a source LUN at a specified point in time. The duplicate is immediately usable and any access to it will have no impact on the source LUN data.
- Clone: locally generates a complete copy for a source LUN at a specified point in time. After the clone task, the destination LUN stores the same data as the source LUN, and their relationship can be split. Then any access to the destination LUN has no impact on the source LUN data.

- LUN copy: replicates data from the source LUN to the destination LUN at block level. A LUN copy task can be performed within a storage system or among storage systems (even if they are heterogeneous).
- HyperMirror: backs up data in real time. If the source data becomes unavailable, applications can automatically use the data copy, ensuring high data security and application continuity.
- Disaster recovery  
Disaster recovery is essential for critical applications that must continue operating even during catastrophic disasters. Disaster recovery technologies involve many aspects such as storage systems, application servers, application software, and technicians. From the storage system aspect, the remote replication technology is used for disaster recovery because it can back up data in real time.  
The technology duplicates backup data in real time across sites, and utilizes the long distance between sites to eliminate data loss. This ensures that data is readily available on other sites if one site is destroyed.

### 3.3 High-Density and Multi-Service Applications

The OceanStor 2200 V3 storage system delivers industry-leading density of interface modules in an enclosure and a flexible configuration of interface modules and disks of different types. This design makes the OceanStor 2200 V3 storage system suitable for high-density and multi-service applications.

#### High-Density Virtual Machine Applications

The virtual machine technology greatly improves application servers' utilization, and lowers services' deployment and operating expense. Therefore, it is popular in many application scenarios. However, virtual machines are now facing a challenge, that is, they are equipped with an increasing number of application systems and virtual desktops, leading to the high density of virtual machines. Compared with a single server, high-density virtual machines generate more service data, consume more bandwidth, and pose more demanding requirements on performance and scalability.

Excellent in both performance and compatibility, the OceanStor 2200 V3 storage system is ideal for high-density virtual machine applications:

- The three-level performance acceleration technology provides robust storage performance for high-density virtual machine applications.
- The proprietary Turbo Module technology significantly improves the density of interface modules in a single enclosure. This high-density design translates into a capability to support hundreds of virtual machines.
- Various virtual machine applications are supported.

#### Multi-Service Applications

It is common for one storage system to process diversified applications. However, those applications have differentiated requirements on storage. Therefore, the storage system must have high flexibility in performance and networking.

Each type of services has its specific requirements for storage system:

- Database servers (featuring unstructured data) have high requirements on storage performance, data integrity, and system stability.
- Mail servers (featuring high randomness of concurrent accesses) have high requirements on storage performance, data integrity, and system stability.
- Video servers have high requirements on storage capacity, data access continuity, and continuous bandwidths.
- Backup servers have low requirements on performance and bandwidths.

The OceanStor 2200 V3 storage system supports an intermixed configuration of SSDs, SAS disks, and NL-SAS disks to deliver optimal performance.

- SSDs: deliver the highest performance among these three types of disk, and are suitable for application servers such as busy database servers and mail servers that require superior storage performance.
- SAS disks: deliver performance lower than SSDs but higher than NL-SAS disks, and are suitable for application servers such as common database servers, mail servers, and high-definition (HD) video servers that have a moderate storage performance requirement.
- NL-SAS disks: deliver the lowest performance among these three types of disk, and are suitable for application servers such as low-end video servers and backup servers that have a low storage performance requirement.

The OceanStor 2200 V3 storage system has a flexible configuration of front-end interface modules with customizable transmission rates, respectively addressing the storage requirements in Fibre Channel networks and Ethernet networks, or of Fibre Channel data transmission in Ethernet networks.

**Figure 3-3** shows a multi-service application scenario.

Figure 3-3 Multi-service application scenario

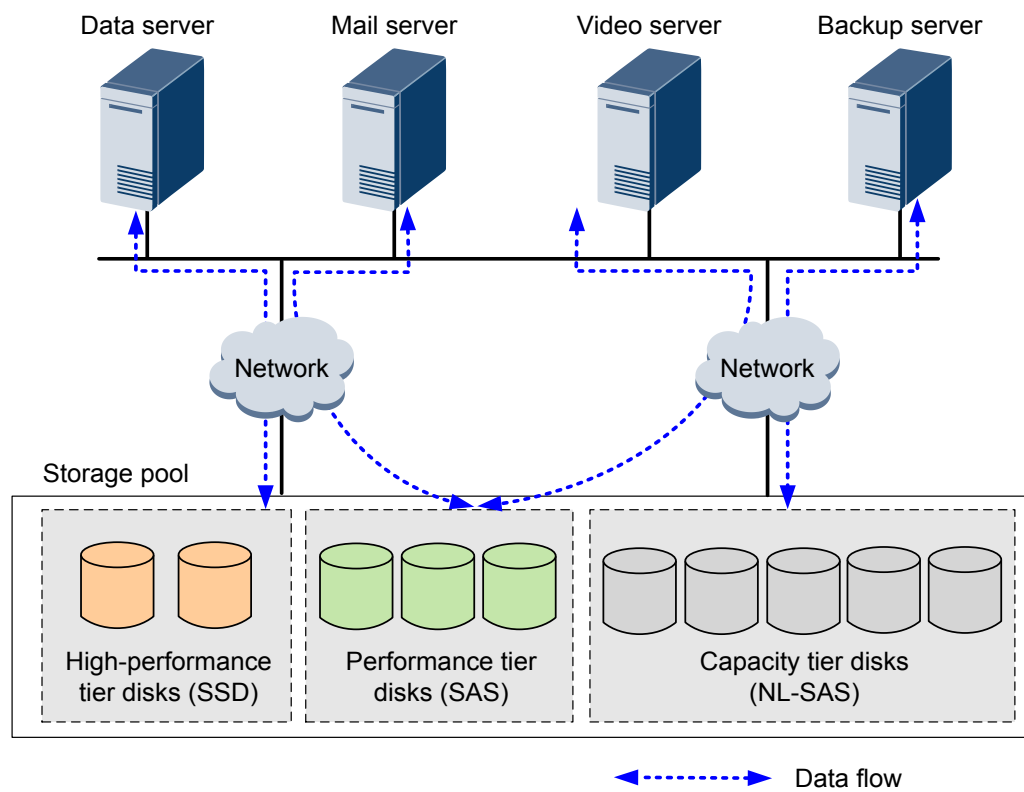



# 4 Hardware Architecture

## About This Chapter

The storage system hardware is the basis of data storage. A storage unit typically consists of a controller enclosure or a controller enclosure paired with disk enclosures.

### 4.1 Device Composition

#### 4.2 2 U Controller Enclosure

#### 4.3 2 U Disk Enclosure (2.5-Inch Disks)

#### 4.4 4 U Disk Enclosure (3.5-Inch Disks)

#### 4.5 Coffer Disk

#### 4.6 Device Cables

## 4.1 Device Composition

A storage system consists of a controller enclosure and one or more disk enclosures, and it provides an intelligent storage platform that features robust reliability, high performance, and large capacity.

Different product models use different types of controller enclosures and disk enclosures.

**Table 4-1** lists the controller enclosures and disk enclosures used by different product models.

**Table 4-1** Controller enclosures and disk enclosures used by different product models

Product Model	Controller Enclosure	Disk Enclosure
OceanStor 2200 V3	<ul style="list-style-type: none"><li>● 2 U controller enclosure with 12 disk slots</li><li>● 2 U controller enclosure with 25 disk slots</li></ul>	<ul style="list-style-type: none"><li>● 2 U disk enclosure with 25 disk slots</li><li>● 4 U disk enclosure with 24 disk slots</li></ul>

The following figures show the appearances of the storage devices.

**Figure 4-1** 2 U controller enclosure with 12 disk slots

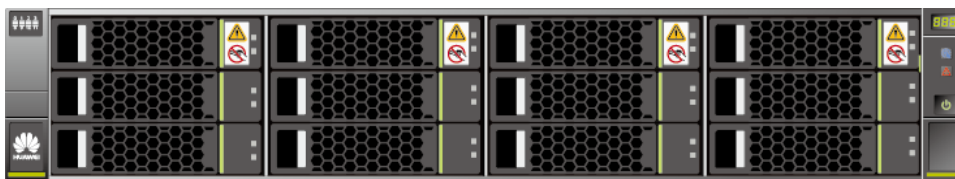

**Figure 4-2** 2 U controller enclosure with 25 disk slots



**Figure 4-3** 2 U disk enclosure with 25 disk slots

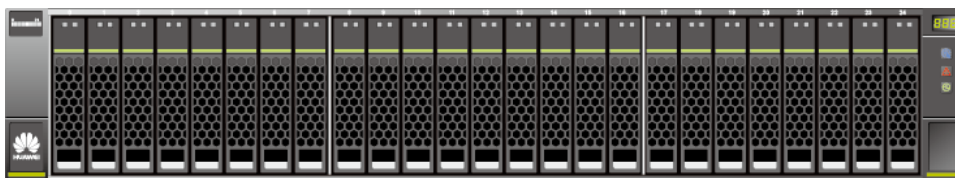

**Figure 4-4** 4 U disk enclosure with 24 disk slots



## 4.2 2 U Controller Enclosure

This section describes a controller enclosure in terms of its hardware structure, component functions, front and rear views, and indicators.

### 4.2.1 Overview

The controller enclosure adopts a modular design and consists of a system subrack, controllers, power modules, and disk modules.

The 2 U controller enclosure of OceanStor 2200 V3 supports AC power modules only, and a 2 U controller enclosure supports dual controllers. The following figure shows the structure of OceanStor 2200 V3 with dual controllers and AC power modules.

## Overall Structure

**Figure 4-5** shows the overall structure of a 2 U 25-disk controller enclosure, and **Figure 4-6** shows the overall structure of a 2 U 12-disk controller enclosure.

**Figure 4-5** Overall structure of a 2 U 25-disk controller enclosure

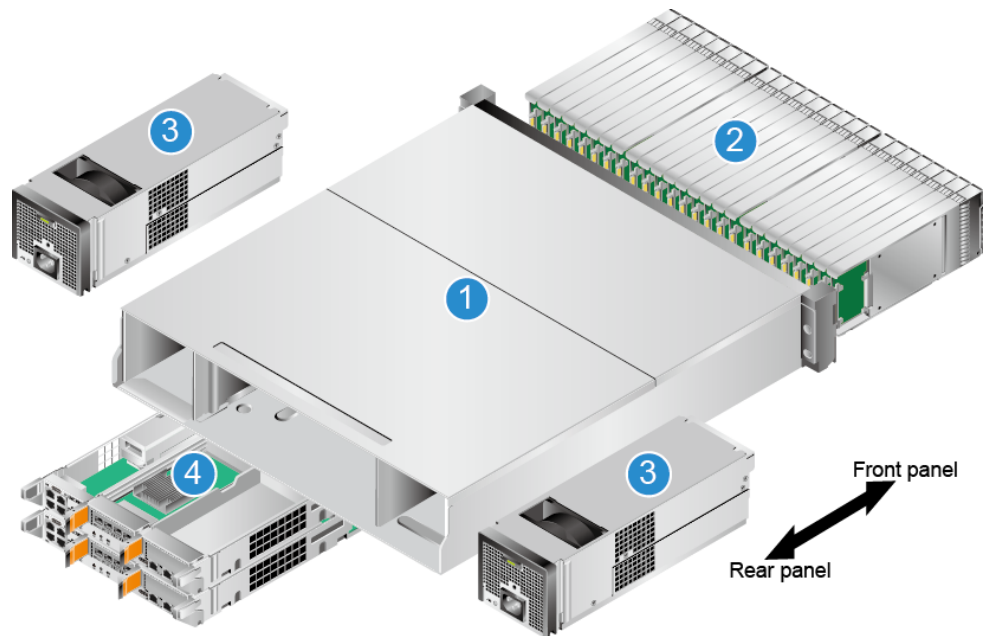

1	System subrack	2	Disk module
3	Power module	4	Controller

**Figure 4-6** Overall structure of a 2 U 12-disk controller enclosure

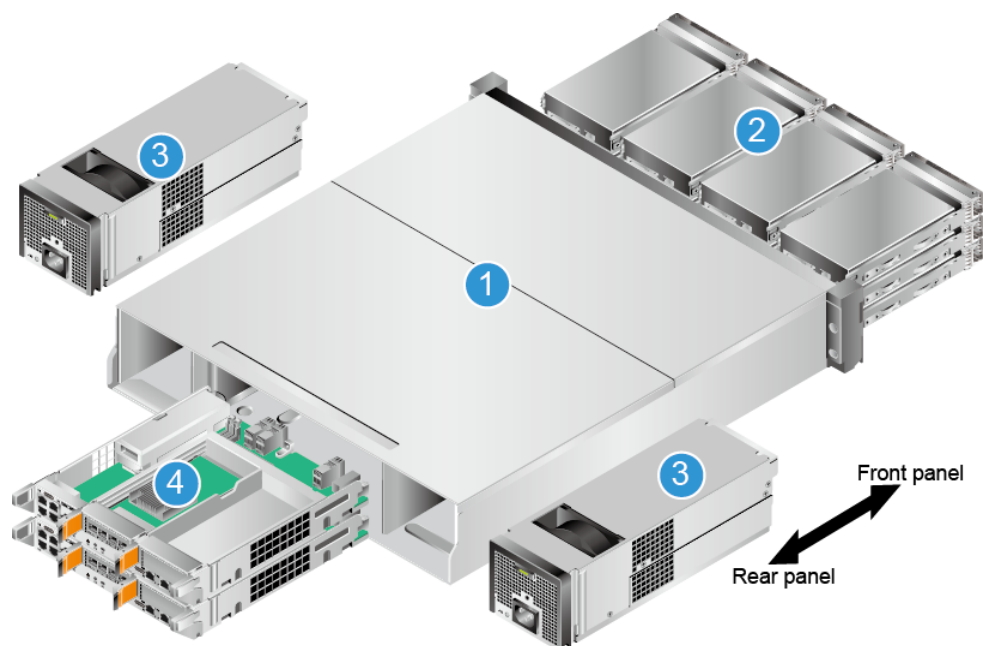

1	System subrack	2	Disk module
3	Power module	4	Controller

**NOTE**

In the rear view of a controller enclosure, controller A is above controller B. Controllers communicate with each other using internal heartbeat links and do not need cable connections.

**Front View**

Figure 4-7 shows the front view of a 2 U 25-disk controller enclosure, and Figure 4-8 shows the front view of a 2 U 12-disk controller enclosure.

Figure 4-7 Front view of a 2 U 25-disk controller enclosure

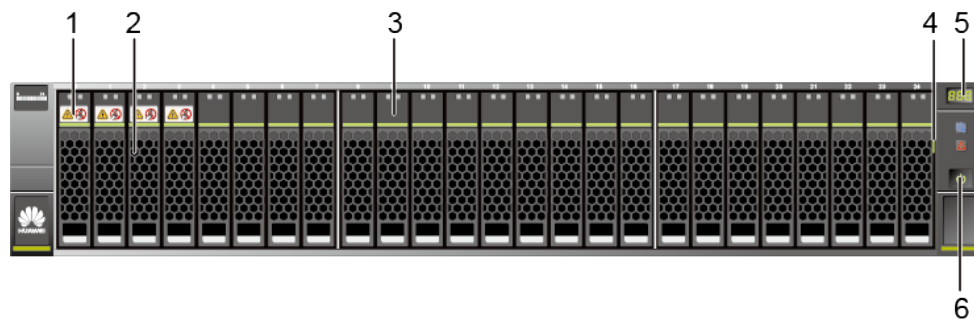

1	Coffer disk label	2	Disk module handle
3	Disk module latch	4	Information plate (with ESN)
5	ID display of the controller enclosure	6	Power indicator/ Power button

Figure 4-8 Front view of a 2 U 12-disk controller enclosure

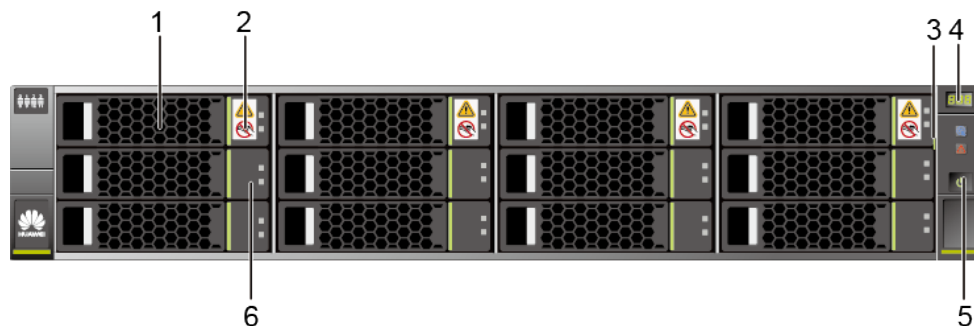

1	Disk module handle	2	Coffer disk label
---	--------------------	---	-------------------

3	Information plate (with ESN)	4	ID display of the controller enclosure
5	Power indicator/ Power button	6	Disk module latch

 **NOTE**

- The disk slots of a 2 U 25-disk controller enclosure are numbered 0 to 24 from left to right. The four coffer disks are located in slot 0 to slot 3.
- The disk slots of a 2 U 12-disk controller enclosure are numbered 0 to 11 from left to right and from top to bottom. The four coffer disks are located in slot 0 to slot 3.
- SAS, NL-SAS, or SSD disks can be used as coffer disks. The type of the four coffer disks must be the same.
- Slots are used to accommodate and secure disks, interface modules, controller modules, fan modules, and power modules.
- The information plate records device information.

## Rear View

**Figure 4-9** shows the rear view of a controller enclosure.

**NOTICE**

Do not connect the management network port and maintenance network port to the same switch.

 **NOTE**

- OceanStor 2200 V3 supports dual controllers. Each controller can house one interface module.
- OceanStor 2200 V3 provides onboard GE electrical ports and mini SAS HD expansion ports.
- The controller enclosure of OceanStor 2200 V3 supports GE electrical interface modules, 10GE electrical interface modules, and SmartIO interface modules.
- When the maintenance network port is used for management and maintenance, the maintenance network port can only be used by Huawei technical support for emergency maintenance and cannot be connected to the same network with the management network port. Otherwise, a network loopback may occur, causing a network storm. The initial value for the IP address of the maintenance network port is 172.31.128.101 or 172.31.128.102. The default subnet mask is 255.255.0.0. You are advised to only connect the management network port to the network.
- **Figure 4-9** shows the 2 U controller enclosure of OceanStor 2200 V3, with dual controllers, AC power supply, and SmartIO interface modules.

**Figure 4-9** Rear view of the OceanStor 2200 V3 controller enclosure (with AC power modules and dual controllers)

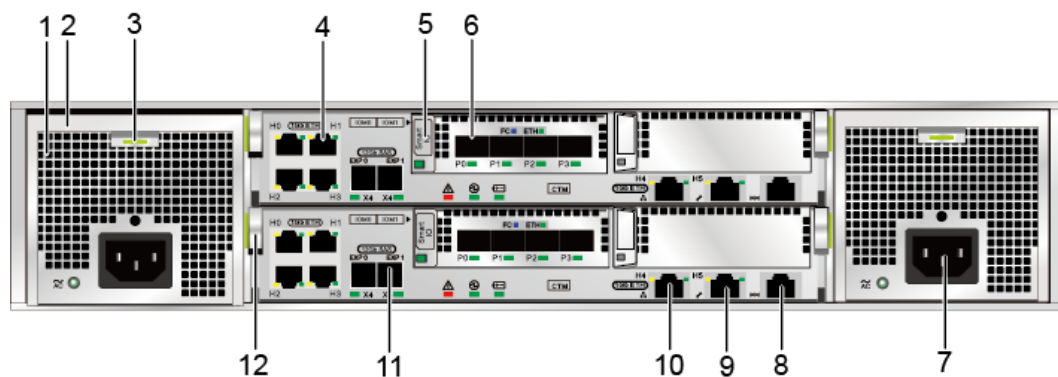

1	Power module	2	Power module handle
3	Power module latch	4	GE electrical port
5	Interface module handle	6	SmartIO port
7	Power socket	8	Serial port
9	Maintenance network port	10	Management network port
11	Mini SAS HD expansion port	12	Controller handle

## 4.2.2 Component Description

This section provides the detailed illustration and description for each component.

### 4.2.2.1 System Subrack

The system subrack houses a midplane to provide reliable connections for interface modules and to distribute power and signals to inner modules.

### Appearance

**Figure 4-10** shows the appearance of a system subrack.

**Figure 4-10** System subrack



### 4.2.2.2 Controller

A controller is the core component of a storage system. It processes storage services, receives configuration management commands, saves configuration data, connects to disk enclosures, and saves critical data onto coffer disks.

 **NOTE**

Each controller has one built-in disk. The disk is used to store the configuration data of the storage system, data in cache after a power failure, and OceanStor OS data. The disks in controller and those in another are redundant for each other.

### Appearance

Each controller supports one interface module.

**Figure 4-11** shows the appearance of a controller.

**Figure 4-11** Controller

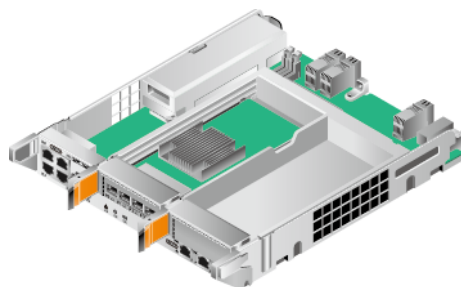

## Ports

Figure 4-12 describes the ports of a controller.

Figure 4-12 Ports of a controller

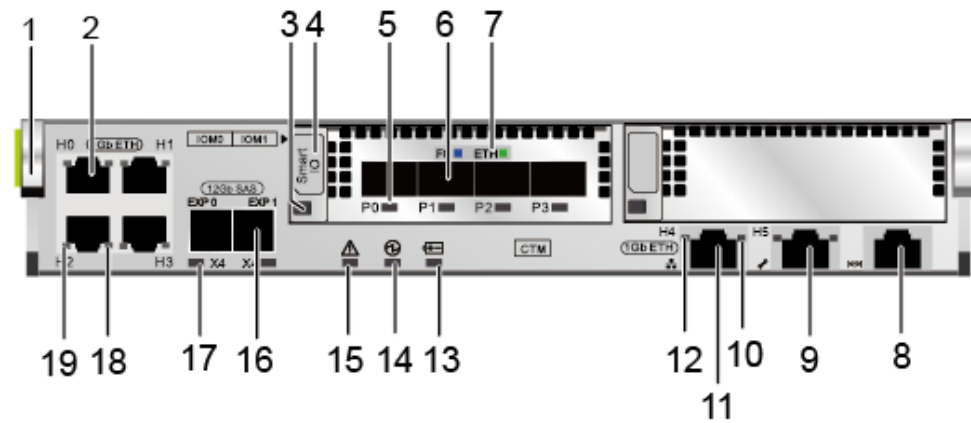

1	Controller handle	2	GE electrical port
3	Power indicator of the interface module/Hot Swap button of the module	4	Interface module handle
5	Link/Active/Mode indicator of the SmartIO port	6	SmartIO port
7	Port mode silkscreen of the SmartIO port	8	Serial port
9	Maintenance network port	10	Link/Active indicator of the management network port
11	Management network port	12	Speed indicator of the management network port
13	Running/Alarm indicator of the backup power module	14	Power indicator of the controller
15	Alarm indicator of the controller	16	Mini SAS HD expansion port
17	Indicator of the mini SAS HD expansion port	18	Link/Active indicator of the GE electrical port



19	Speed indicator of the GE electrical port	-	-
----	---	---	---

## Indicators

**Table 4-2** describes the states and corresponding meanings of indicators on a controller after it is powered on.

**Table 4-2** Checklist for indicators on a controller

No.	Indicator	Status and Description
3	Power indicator of the interface module/Hot Swap button of the module	<ul style="list-style-type: none"> <li>● Steady green: The interface module is running properly.</li> <li>● Blinking green: The interface module receives a hot swap request.</li> <li>● Steady red: The interface module is faulty.</li> <li>● Off: The interface module is powered off or can be hot-swappable.</li> </ul>
5	Link/Active/Mode indicator of the SmartIO port	<ul style="list-style-type: none"> <li>● Blinking blue slowly (1 Hz): The interface module is working in FC mode, and the port link is down.</li> <li>● Blinking blue quickly (2 Hz): The interface module is working in FC mode, and data is being transmitted.</li> <li>● Steady blue: The interface module is working in FC mode, the port link is up, and no data is being transmitted.</li> <li>● Blinking green slowly (1 Hz): The interface module is working in ETH mode, and the port link is down.</li> <li>● Blinking green quickly (2 Hz): The interface module is working in ETH mode, and data is being transmitted.</li> <li>● Steady green: The interface module is working in ETH mode, the port link is up, and no data is being transmitted.</li> <li>● Steady red: The port is faulty.</li> <li>● Off: The port is not powered on.</li> </ul>
10	Link/Active indicator of the management network port	<ul style="list-style-type: none"> <li>● Steady green: The port is connected properly.</li> <li>● Blinking green: Data is being transferred.</li> <li>● Off: The port is connected abnormally.</li> </ul>

No.	Indicator	Status and Description
12	Speed indicator of the management network port	<ul style="list-style-type: none"> <li>● Steady orange: Data is being transferred at the highest rate.</li> <li>● Off: The data transfer speed is lower than the highest speed.</li> </ul>
13	Running/Alarm indicator of the backup power module	<ul style="list-style-type: none"> <li>● Steady green: The backup power module is fully charged.</li> <li>● Blinking green (1 Hz): The backup power module is being charged.</li> <li>● Blinking green (4 Hz): The backup power module is being discharged.</li> <li>● Steady red: The backup power module is faulty.</li> </ul>
14	Power indicator of the controller	<ul style="list-style-type: none"> <li>● Steady green: The controller is powered on.</li> <li>● Blinking green (0.5 Hz): The controller enclosure is powered on and in the BIOS boot process.</li> <li>● Blinking green (2 Hz): The controller is in the operating system boot process, or the controller is in the power-off process.</li> <li>● Off: The controller is absent or powered off.</li> </ul>
15	Alarm indicator of the controller	<ul style="list-style-type: none"> <li>● Steady red: An alarm is generated on the controller.</li> <li>● The Alarm indicator blinking red and the Power indicator blinking green: The controller is being located.</li> <li>● Off: The controller is working correctly.</li> </ul>
17	Indicator of the mini SAS HD expansion port	<ul style="list-style-type: none"> <li>● Steady blue: Data is transferred to the downstream disk enclosure at the rate of 4 x 12 Gbit/s.</li> <li>● Steady green: Data is transferred to the downstream disk enclosure at the rate of 4 x 3 Gbit/s or 4 x 6 Gbit/s.</li> <li>● Steady red: The port is faulty.</li> <li>● Off: The link to the port is down.</li> </ul>
18	Link/Active indicator of the GE electrical port	<ul style="list-style-type: none"> <li>● Steady green: The link to the application server is normal.</li> <li>● Blinking green: Data is being transferred.</li> <li>● Off: The link to the application server is down or no link exists.</li> </ul>

No.	Indicator	Status and Description
19	Speed indicator of the GE electrical port	<ul style="list-style-type: none"> <li>● Steady orange: The data transfer rate between the storage system and the application server is 1 Gbit/s.</li> <li>● Off: The data transfer rate between the storage system and the application server is less than 1 Gbit/s.</li> </ul>

### 4.2.2.3 Power Module

Power modules can ensure that the controller enclosure works correctly in maximum power consumption mode.

#### Appearance

Figure 4-13 shows the front view of an AC power module.

Figure 4-13 Front view of an AC power module

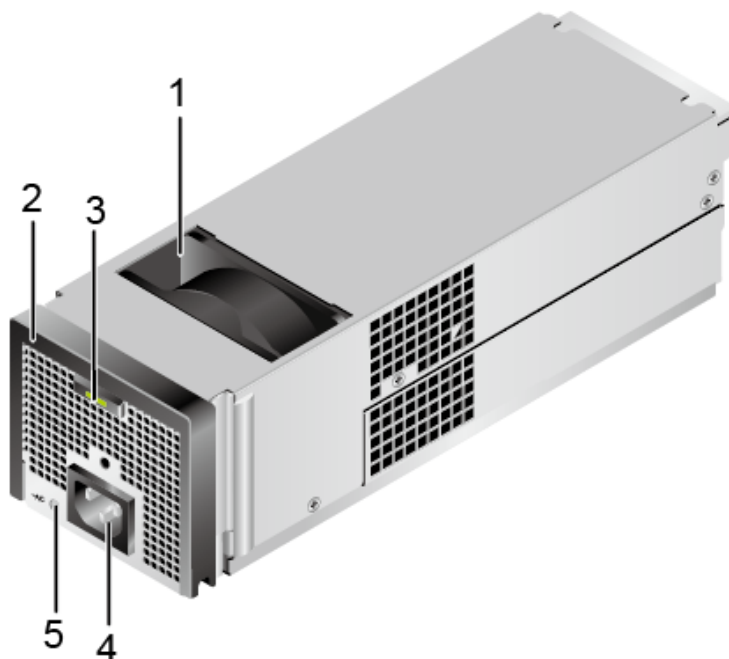

1	Fan built in the power module	2	Power module handle
3	Power module latch	4	Power module socket
5	Running/Alarm indicator of the power module		

## Indicators

**Table 4-3** describes indicators on a power module of a powered-on storage system.

**Table 4-3** Indicators on a power module

No.	Indicator	Status and Description
5	Running/Alarm indicator of the power module	<ul style="list-style-type: none"> <li>● Steady green: The power supply is correct.</li> <li>● Green blinking: The power input is normal but the enclosure is powered off.</li> <li>● Steady red: The power supply is faulty.</li> <li>● Off: No external power input is found.</li> </ul>

### 4.2.2.4 Disk Module

Disk modules provide storage capacity for a storage system. Disk modules can function as system coffer disks to save service data, system data, and cache data.

## Appearance

**Figure 4-14** shows the appearance of a 2.5-inch disk module. **Figure 4-15** shows the appearance of a 3.5-inch disk module.

**Figure 4-14** 2.5-inch disk module

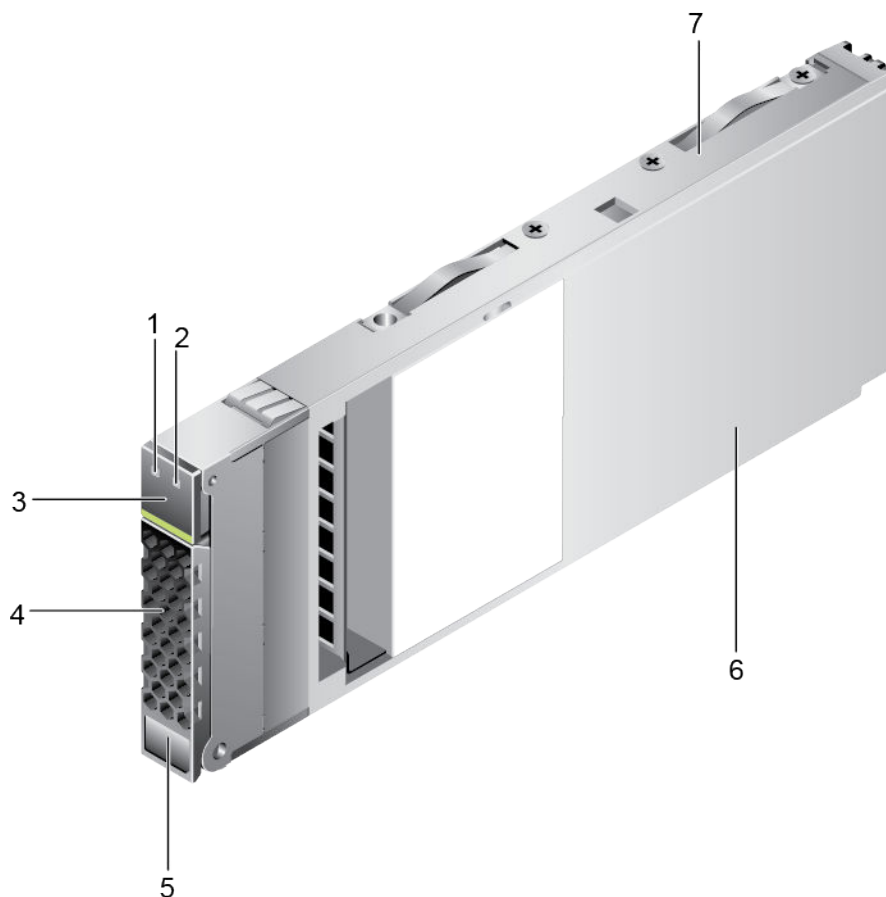

**Figure 4-15** 3.5-inch disk module

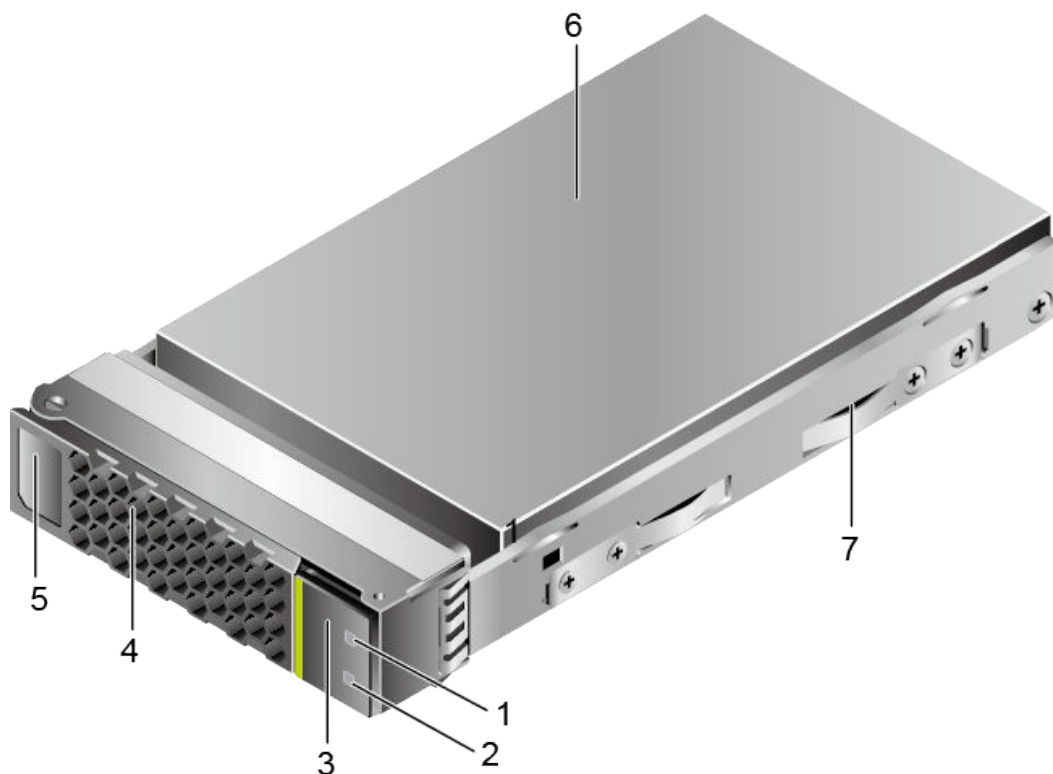

1	Running indicator of the disk module	2	Alarm/Location indicator of the disk module
3	Disk module latch	4	Disk module handle
5	Disk module label	6	Disk
7	Disk tray	-	-

## Indicators

**Table 4-4** describes indicators on a disk module of a powered-on storage system.

**Table 4-4** Indicators on a disk module

No.	Indicator	Status and Description
1	Running indicator of the disk module	<ul style="list-style-type: none"> <li>● Steady green: The disk module is working correctly.</li> <li>● Blinking green: Data is being read and written on the disk module.</li> <li>● Off: The disk module is powered off or powered on incorrectly.</li> </ul>

No.	Indicator	Status and Description
2	Alarm/Location indicator of the disk module	<ul style="list-style-type: none"> <li>● Steady red: The disk module is faulty.</li> <li>● Blinking red: The disk module is being located.</li> <li>● Off: The disk module is working correctly or hot swappable.</li> </ul>

### 4.2.2.5 GE Electrical Interface Module

#### Function

A GE electrical interface module has four 1 Gbit/s electrical ports.

#### Ports

Figure 4-16 shows the appearance of a GE electrical interface module.

Figure 4-16 GE electrical interface module

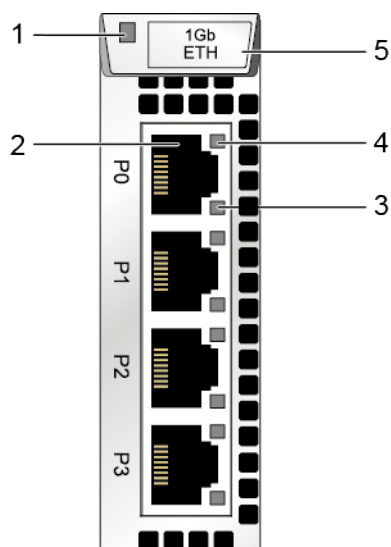

1	Power indicator/Hot Swap button on the interface module	2	GE electrical port
3	Link/Active indicator of the GE electrical port	4	Speed indicator of the GE electrical port
5	Interface module handle	-	-

## Indicators

**Table 4-5** describes indicators on a GE electrical interface module of a powered-on storage system.

**Table 4-5** Indicators on a GE electrical interface module

No.	Indicator	Status and Description
1	Power indicator/Hot Swap button on the interface module	<ul style="list-style-type: none"> <li>● Steady green: The interface module is working correctly.</li> <li>● Blinking green: There is a hot swap request to the module.</li> <li>● Steady red: The module is faulty.</li> <li>● Off: The interface module is powered off or hot swappable.</li> </ul>
3	Link/Active indicator of the GE electrical port	<ul style="list-style-type: none"> <li>● Steady green: The link to the application server is normal.</li> <li>● Blinking green: Data is being transferred.</li> <li>● Off: The link to the application server is down or no link exists.</li> </ul>
4	Speed indicator of the GE electrical port	<ul style="list-style-type: none"> <li>● Steady yellow: The data transfer rate between the storage system and the application server is 1 Gbit/s.</li> <li>● Off: The data transfer rate between the storage system and the application server is less than 1 Gbit/s.</li> </ul>

### 4.2.2.6 10GE Electrical Interface Module

#### Function

A 10GE electrical interface module has four 10 Gbit/s electrical ports.

#### Ports

**Figure 4-17** shows the appearance of a 10GE electrical interface module. 10GE electrical interface modules of the storage system support GE/10GE autonegotiation.

**Figure 4-17** 10GE electrical interface module

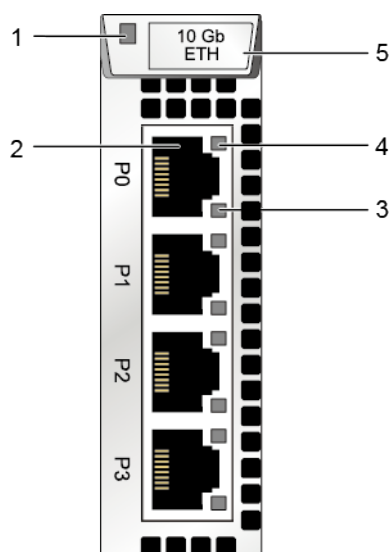

1	Power indicator/Hot Swap button on the interface module	2	10GE electrical port
3	Link/Active indicator of the 10GE electrical port	4	Speed indicator of the 10GE electrical port
5	Interface module handle	-	-

## Indicators

**Table 4-6** describes indicators on a 10GE electrical interface module of a powered-on storage system.

**Table 4-6** Indicators on a 10GE electrical interface module

No.	Indicator	Status and Description
1	Power indicator/Hot Swap button on the interface module	<ul style="list-style-type: none"> <li>● Steady green: The interface module is working correctly.</li> <li>● Blinking green: There is a hot swap request to the module.</li> <li>● Steady red: The module is faulty.</li> <li>● Off: The module is powered off or hot swappable.</li> </ul>



No.	Indicator	Status and Description
3	Link/Active indicator of the 10GE electrical port	<ul style="list-style-type: none"> <li>● Steady green: The link to the application server is normal.</li> <li>● Blinking green: Data is being transferred.</li> <li>● Off: The link to the application server is down or no link exists.</li> </ul>
4	Speed indicator of the 10GE electrical port	<ul style="list-style-type: none"> <li>● Steady yellow: The data transfer rate between the storage system and the application server is 10 Gbit/s.</li> <li>● Off: The data transfer rate between the storage system and the application server is less than 10 Gbit/s.</li> </ul>

#### 4.2.2.7 8 Gbit/s Fibre Channel Interface Module (Eight Ports)

##### Function

An 8 Gbit/s Fibre Channel interface module (eight ports) provides two ports and can be converted to eight 8 Gbit/s Fibre Channel ports through dedicated fiber cables. If the port speed is auto-negotiable, the port will auto-negotiate 2 Gbit/s, 4 Gbit/s, or 8 Gbit/s. If the port speed is manually set but inconsistent with the data transfer speed of the connected application server, the connection will be interrupted.

##### Interface

**Figure 4-18** shows the appearance of an 8 Gbit/s Fibre Channel interface module (eight ports).

**Figure 4-18** 8 Gbit/s Fibre Channel interface module (eight ports)

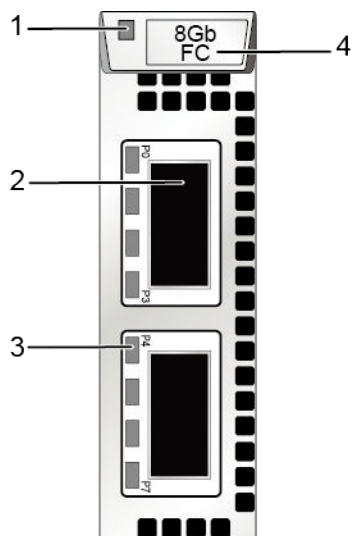

1	Power indicator/Hot Swap button	2	8 Gbit/s Fibre Channel ports
3	Port Link/Speed indicator	4	Module handle

## Indicators

**Table 4-7** describes the states of indicators and their meanings on an 8 Gbit/s Fibre Channel interface module (eight ports) after the storage device is powered on.

**Table 4-7** Indicator status description for an 8 Gbit/s Fibre Channel interface module (eight ports)

No.	Indicator	Status Description
1	Module Power/Hot Swap indicator	<ul style="list-style-type: none"> <li>● Steady green: The interface module is running properly.</li> <li>● Blinking green: The interface module receives a hot swap request.</li> <li>● Steady red: The interface module is faulty.</li> <li>● Off: The interface module is powered off or can be hot-swappable.</li> </ul>
3	Link/Speed indicator of the 8 Gbit/s Fibre Channel port	<ul style="list-style-type: none"> <li>● Steady blue: Data is being transmitted between the storage system and the application server at a rate of 8 Gbit/s.</li> <li>● Blinking blue: Data is being transferred.</li> <li>● Steady green: Data is being transmitted between the storage system and the application server at a rate of 2 Gbit/s or 4 Gbit/s.</li> <li>● Blinking green: Data is being transferred.</li> <li>● Steady red: The port is faulty.</li> <li>● Off: The port link is down.</li> </ul>

### 4.2.2.8 SmartIO Interface Module (Two Ports)

#### Function

A 2-port SmartIO interface module provides 10 Gbit/s and 16 Gbit/s optical transceiver for front-end module.

#### Interface

**Figure 4-19** shows the components of a two-port SmartIO interface module.

**NOTE**

Do not remove dust plugs installed in ports P2 and P3 to protect the module against the dust.

**Figure 4-19** SmartIO interface module

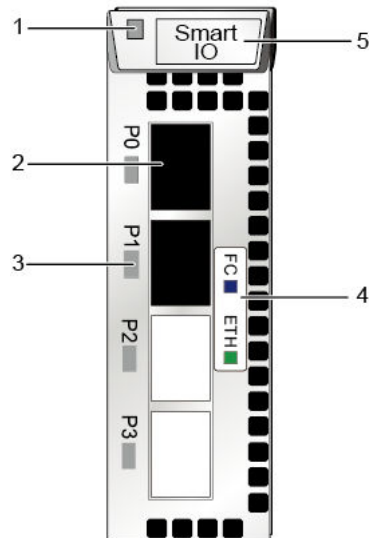

1	Power indicator/Hot Swap button	2	SmartIO port
3	Port Link/Active/Mode indicator	4	Port mode silkscreen
5	Module handle	-	-

## Indicators

**Table 4-8** describes the states of indicators and their meanings on a SmartIO interface module after the storage device is powered on.

**Table 4-8** Indicator status description for a SmartIO interface module

No.	Indicator	Status Description
1	Power indicator/Hot Swap button	<ul style="list-style-type: none"> <li>● Steady green: The interface module is running properly.</li> <li>● Blinking green: The interface module receives a hot swap request.</li> <li>● Steady red: The interface module is faulty.</li> <li>● Off: The interface module is powered off or can be hot-swappable.</li> </ul>

No.	Indicator	Status Description
3	Port Link/Active/Mode indicator	<ul style="list-style-type: none"> <li>● Blinking blue slowly (1 Hz): The interface module is working in FC mode, and the port link is down.</li> <li>● Blinking blue quickly (2 Hz): The interface module is working in FC mode, and data is being transmitted.</li> <li>● Steady blue: The interface module is working in FC mode, the port link is up, and no data is being transmitted.</li> <li>● Blinking green slowly (1 Hz): The interface module is working in ETH mode, and the port link is down.</li> <li>● Blinking green quickly (2 Hz): The interface module is working in ETH mode, and data is being transmitted.</li> <li>● Steady green: The interface module is working in ETH mode, the port link is up, and no data is being transmitted.</li> <li>● Steady red: The port is faulty.</li> <li>● Off: The port is not powered on.</li> </ul>

 **NOTE**

The SmartIO interface module supports multiple working modes which need to be adjusted based on the used optical module. For details, see section "Checking and Setting the Working Mode of SmartIO Interface Modules" in the *Installation Guide*.

### 4.2.2.9 SmartIO Interface Module (Four Ports)

#### Function

A four-port SmartIO interface module provides 8 Gbit/s, 10 Gbit/s, and 16 Gbit/s optical transceiver.

#### Interface

[Figure 4-20](#) shows the components of a four-port SmartIO interface module.

**Figure 4-20** SmartIO interface module

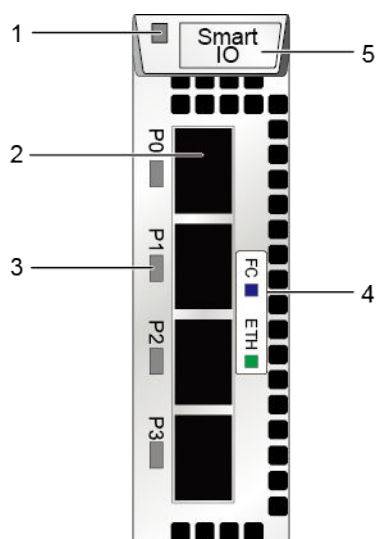

1	Power indicator/Hot Swap button	2	SmartIO port
3	Port link/active/mode indicator	4	Port mode silkscreen
5	Module handle	-	-

## Indicators

**Table 4-9** describes the states of indicators and their meanings on a SmartIO interface module after the storage device is powered on.

**Table 4-9** Indicator status description for a SmartIO interface module

No.	Indicator	Status Description
1	Power indicator/Hot Swap button	<ul style="list-style-type: none"> <li>● Steady green: The interface module is running properly.</li> <li>● Blinking green: The interface module receives a hot swap request.</li> <li>● Steady red: The interface module is faulty.</li> <li>● Off: The interface module is powered off or can be hot-swappable.</li> </ul>

No.	Indicator	Status Description
3	Port link/active/mode indicator	<ul style="list-style-type: none"> <li>● Blinking blue slowly (1 Hz): The interface module is working in FC mode, and the port link is down.</li> <li>● Blinking blue quickly (2 Hz): The interface module is working in FC mode, and data is being transmitted.</li> <li>● Steady blue: The interface module is working in FC mode, the port link is up, and no data is being transmitted.</li> <li>● Blinking green slowly (1 Hz): The interface module is working in ETH mode, and the port link is down.</li> <li>● Blinking green quickly (2 Hz): The interface module is working in ETH mode, and data is being transmitted.</li> <li>● Steady green: The interface module is working in ETH mode, the port link is up, and no data is being transmitted.</li> <li>● Steady red: The port is faulty.</li> <li>● Off: The port is not powered on.</li> </ul>

 **NOTE**

The SmartIO interface module supports multiple working modes which need to be adjusted based on the used optical module. For details, see section "Checking and Setting the Working Mode of SmartIO Interface Modules" in the *Installation Guide*.

### 4.2.3 Indicator Introduction

After a controller enclosure is powered on, you can check the current operating status of the controller enclosure by viewing its indicators.

#### Indicators on the Front Panel

**Figure 4-21** shows the indicators on the front panel of a 2 U 25-disk controller enclosure and **Figure 4-22** shows the indicators on the front panel of a 2 U 12-disk controller enclosure.

**Figure 4-21** Indicators on the front panel of a 2 U 25-disk controller enclosure

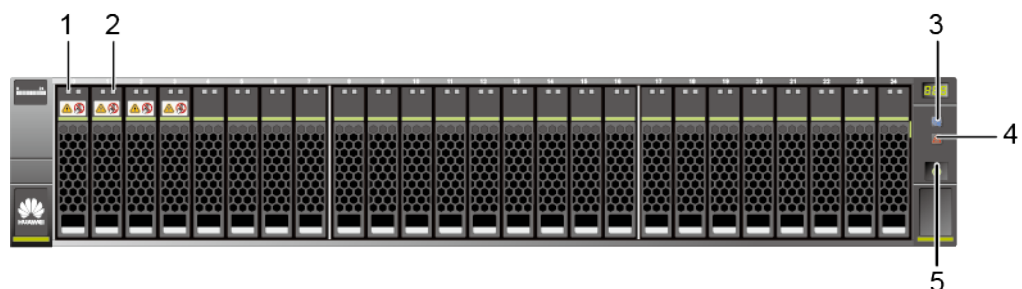

1	Running indicator of the disk module	2	Location/Alarm indicator of the disk module
3	Location indicator of the controller enclosure	4	Alarm indicator of the controller enclosure
5	Power indicator/ Power button of the controller enclosure		

**Figure 4-22** Indicators on the front panel of a 2 U 12-disk controller enclosure

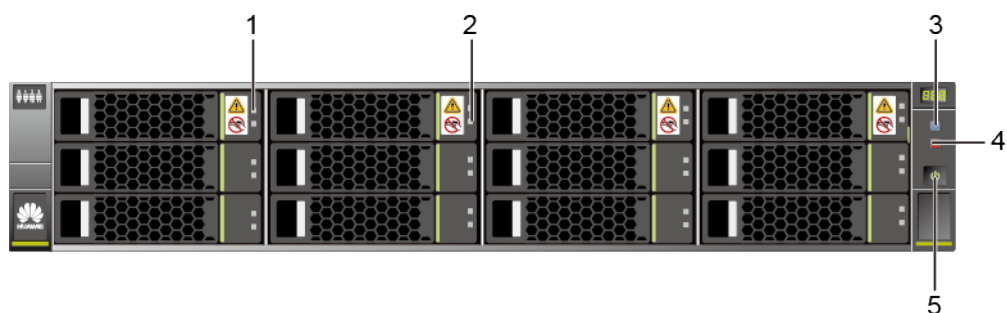

1	Running indicator of the disk module	2	Location/Alarm indicator of the disk module
3	Location indicator of the controller enclosure	4	Alarm indicator of the controller enclosure
5	Power indicator/ Power button of the controller enclosure		

**Table 4-10** describes the indicators on the front panel of a controller enclosure.

**Table 4-10** Description of the indicators on the front panel of a controller enclosure

Module	No.	Indicator	Status and Description
Disk module	1	Running indicator of the disk module	<ul style="list-style-type: none"> <li>● Steady green: The disk module is working correctly.</li> <li>● Blinking green: Data is being read and written on the disk module.</li> <li>● Off: The disk module is powered off or powered on incorrectly.</li> </ul>
	2	Location/Alarm indicator of the disk module	<ul style="list-style-type: none"> <li>● Steady red: The disk module is faulty.</li> <li>● Blinking red: The disk module is being located.</li> <li>● Off: The disk module is working correctly or hot swappable.</li> </ul>
System subrack	3	Location indicator of the controller enclosure	<ul style="list-style-type: none"> <li>● Blinking blue: The controller enclosure is being located.</li> <li>● Off: The controller enclosure is not located.</li> </ul>
	4	Alarm indicator of the controller enclosure	<ul style="list-style-type: none"> <li>● Steady red: An alarm whose severity is major or higher is generated on the storage system.</li> <li>● Off: The storage system is running properly.</li> </ul>
	5	Power indicator/Power button of the controller enclosure	<ul style="list-style-type: none"> <li>● Steady green: The controller enclosure is powered on.</li> <li>● Blinking green (0.5 Hz): The controller enclosure is being powered on.</li> <li>● Blinking green (1 Hz): The controller enclosure is in the burn-in test.</li> <li>● Blinking green (2 Hz): The controller enclosure is in the operating system boot process, or is being powered off.</li> <li>● Off: The controller enclosure is powered off or is in the standby state.</li> </ul>

## Indicators on the Rear Panel

**Figure 4-23** shows the indicators on the rear panel of a controller enclosure.



**Figure 4-23** Indicators on the rear panel of a controller enclosure

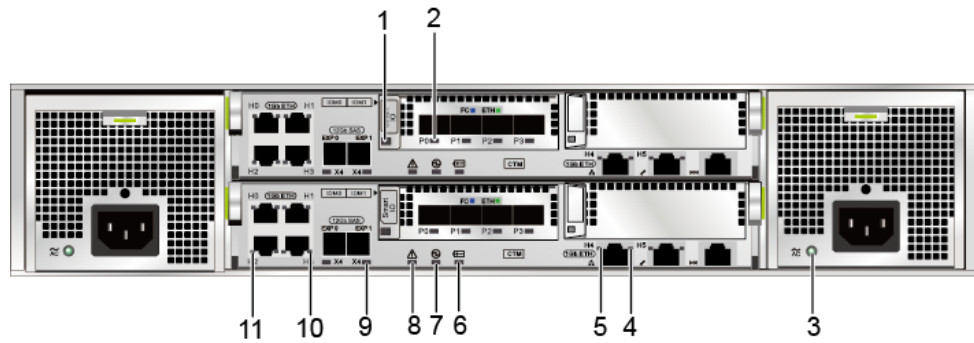

1	Power indicator of the interface module/Hot Swap button of the module	2	Link/Active/Mode indicator of the SmartIO port
3	Running/Alarm indicator of the power module	4	Link/Active indicator of the management network port
5	Speed indicator of the management network port	6	Running/Alarm indicator of the backup power module
7	Power indicator of the controller	8	Alarm indicator of the controller
9	Indicator of the mini SAS HD expansion port	10	Link/Active indicator of the GE electrical port
11	Speed indicator of the GE electrical port		

**Table 4-11** describes the indicators on the rear panel of a controller enclosure.

**Table 4-11** Description of the indicators on the rear panel of a controller enclosure

Module	No.	Indicator	Status and Description
Interface module	1	Power indicator of the interface module/Hot Swap button of the module	<ul style="list-style-type: none"> <li>● Steady green: The interface module is running properly.</li> <li>● Blinking green: The interface module receives a hot swap request.</li> <li>● Steady red: The interface module is faulty.</li> <li>● Off: The interface module is powered off or can be hot-swappable.</li> </ul>
	2	Link/Active/Mode indicator of the SmartIO port	<ul style="list-style-type: none"> <li>● Blinking blue slowly (1 Hz): The interface module is working in FC mode, and the port link is down.</li> <li>● Blinking blue quickly (2 Hz): The interface module is working in FC mode, and data is being transmitted.</li> <li>● Steady blue: The interface module is working in FC mode, the port link is up, and no data is being transmitted.</li> <li>● Blinking green slowly (1 Hz): The interface module is working in ETH mode, and the port link is down.</li> <li>● Blinking green quickly (2 Hz): The interface module is working in ETH mode, and data is being transmitted.</li> <li>● Steady green: The interface module is working in ETH mode, the port link is up, and no data is being transmitted.</li> <li>● Steady red: The port is faulty.</li> <li>● Off: The port is not powered on.</li> </ul>
Power module	3	Running/Alarm indicator of the power module	<ul style="list-style-type: none"> <li>● Steady green: The power supply is correct.</li> <li>● Blinking green: The power input is normal but the disk enclosure is powered off.</li> <li>● Steady red: The power module is faulty.</li> <li>● Off: No external power input is found.</li> </ul>
Controller	4	Link/Active indicator of the management network port	<ul style="list-style-type: none"> <li>● Steady green: The port is connected properly.</li> <li>● Blinking green: Data is being transferred.</li> <li>● Off: The port is connected abnormally.</li> </ul>
	5	Speed indicator of the management network port	<ul style="list-style-type: none"> <li>● Steady orange: Data is being transferred at the highest rate.</li> <li>● Off: The data transfer speed is lower than the highest speed.</li> </ul>

Module	No.	Indicator	Status and Description
	6	Running/ Alarm indicator of the backup power module	<ul style="list-style-type: none"> <li>● Steady green: The backup power module is fully charged.</li> <li>● Blinking green (1 Hz): The backup power module is being charged.</li> <li>● Blinking green (4 Hz): The backup power module is being discharged.</li> <li>● Steady red: The backup power module is faulty.</li> </ul>
	7	Power indicator of the controller	<ul style="list-style-type: none"> <li>● Steady green: The controller is powered on.</li> <li>● Blinking green (0.5 Hz): The controller enclosure is powered on and in the BIOS boot process.</li> <li>● Blinking green (2 Hz): The controller is in the operating system boot process, or the controller is in the power-off process.</li> <li>● Off: The controller is absent or powered off.</li> </ul>
	8	Alarm indicator of the controller	<ul style="list-style-type: none"> <li>● Steady red: An alarm is generated on the controller.</li> <li>● The Alarm indicator blinking red and the Power indicator blinking green: The controller is being located.</li> <li>● Off: The controller is working correctly.</li> </ul>
	9	Indicator of the mini SAS HD expansion port	<ul style="list-style-type: none"> <li>● Steady blue: Data is transferred to the downstream disk enclosure at the rate of 4 x 12 Gbit/s.</li> <li>● Steady green: Data is transferred to the downstream disk enclosure at the rate of 4 x 3 Gbit/s or 4 x 6 Gbit/s.</li> <li>● Steady red: The port is faulty.</li> <li>● Off: The link to the port is down.</li> </ul>
	10	Link/Active indicator of the GE electrical port	<ul style="list-style-type: none"> <li>● Steady green: The link to the application server is normal.</li> <li>● Blinking green: Data is being transferred.</li> <li>● Off: The link to the application server is down or no link exists.</li> </ul>
	11	Speed indicator of the GE electrical port	<ul style="list-style-type: none"> <li>● Steady orange: The data transfer rate between the storage system and the application server is 1 Gbit/s.</li> <li>● Off: The data transfer rate between the storage system and the application server is less than 1 Gbit/s.</li> </ul>

## 4.3 2 U Disk Enclosure (2.5-Inch Disks)

This section describes a disk enclosure in terms of its hardware structure, component functions, front and rear views, and indicators.

### 4.3.1 Overview

The disk enclosure consists of a system subrack, expansion modules, disk modules, and power modules.

#### Overall Structure

Figure 4-24 shows the overall structure of a 2 U SAS disk enclosure.

Figure 4-24 Overall structure of a 2 U SAS disk enclosure

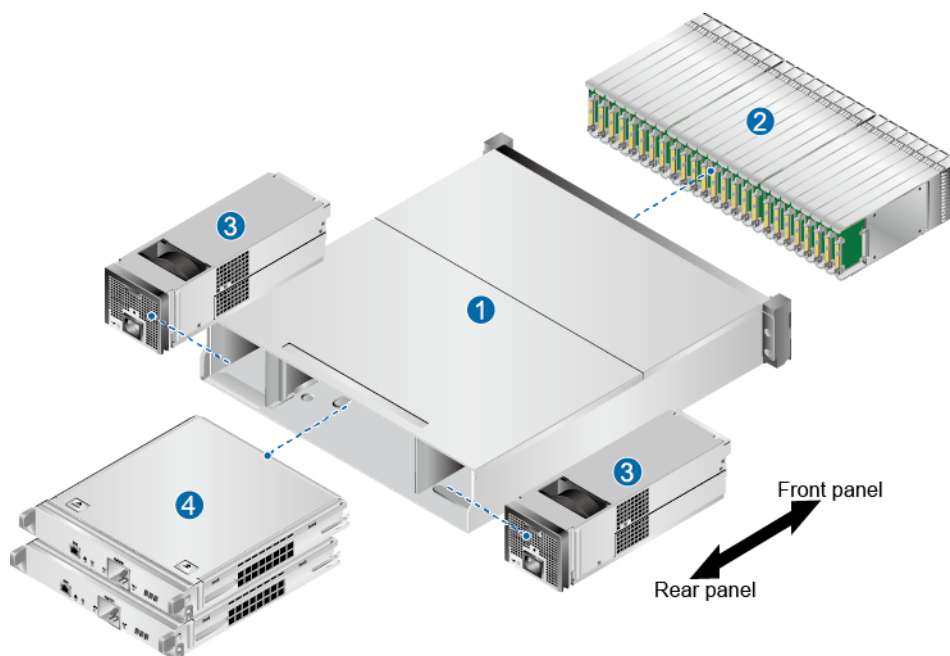

1	System subrack	2	Disk module
3	Power module	4	Expansion module

#### Front View

Figure 4-25 shows the front view of a 2 U disk enclosure.

**Figure 4-25** Front view of a 2 U disk enclosure

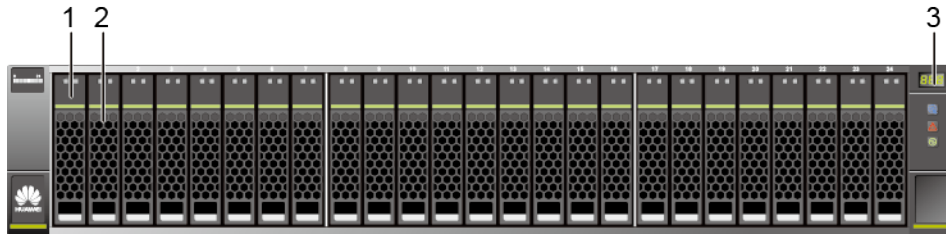

1	Disk module latch	2	Disk module handle
3	ID display of the disk enclosure		

**NOTE**

The disk slots are numbered 0 to 24 from left to right.

**Rear View**

**Figure 4-26** shows the rear view of a disk enclosure with the AC power module.

**Figure 4-26** Rear view of a disk enclosure with the AC power module

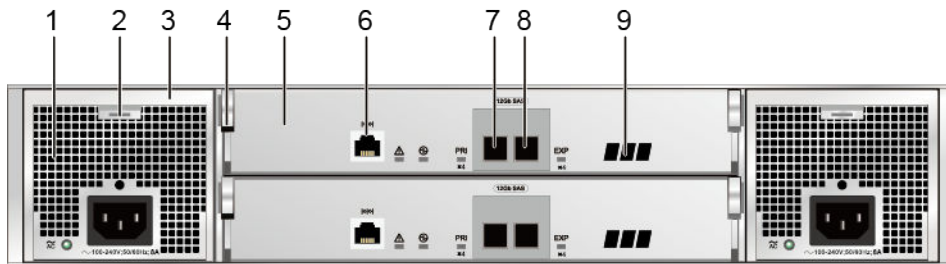

1	Power module	2	Power module latch
3	Power module handle	4	Expansion module handle
5	Expansion module	6	Serial port
7	Mini SAS HD PRI expansion port	8	Mini SAS HD EXP expansion port
9	Disk enclosure ID display	-	-

**4.3.2 Component Description**

This section provides the detailed illustration and description for each component.

### 4.3.2.1 System Subrack

The system subrack houses a midplane to provide reliable connections for interface modules and to distribute power and signals to inner modules.

#### Appearance

**Figure 4-27** shows the appearance of a system subrack.

**Figure 4-27** System subrack



### 4.3.2.2 Expansion Module

An expansion module provides expansion ports for communication between the disk enclosure and the controller enclosure. Each expansion module provides a PRI expansion port and an EXP expansion port.

#### Appearance

**Figure 4-28** shows the appearance of an expansion module.

**Figure 4-28** Expansion module



## Ports

**Figure 4-29** shows the ports of an expansion module.

**Figure 4-29** Interfaces of an expansion module

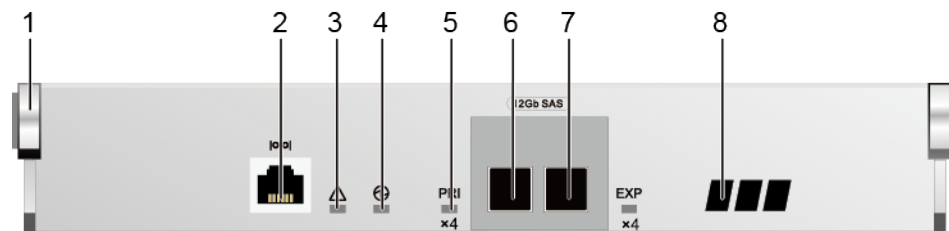

1	Expansion module handle	2	Serial port
3	Alarm indicator of the expansion module	4	Power indicator of the expansion module
5	Indicator of the mini SAS HD expansion port	6	Mini SAS HD PRI expansion port
7	Mini SAS HD EXP expansion port	8	Disk enclosure ID display

## Indicators

**Table 4-12** describes indicators on an expansion module of a powered-on storage system.

**Table 4-12** Indicators on an expansion module

No.	Indicator	Status and Description
3	Alarm indicator of the expansion module	<ul style="list-style-type: none"> <li>● Steady red: An alarm is generated in the expansion module.</li> <li>● Off: The expansion module is working correctly.</li> </ul>
4	Power indicator of the expansion module	<ul style="list-style-type: none"> <li>● Steady green: The expansion module is powered on.</li> <li>● Off: The expansion module is powered off.</li> </ul>
5	Indicator of the mini SAS HD expansion port	<ul style="list-style-type: none"> <li>● Steady blue: Data is transferred to the downstream disk enclosure at the rate of 4 x 12 Gbit/s.</li> <li>● Steady green: Data is transferred to the downstream disk enclosure at the rate of 4 x 3 Gbit/s or 4 x 6 Gbit/s.</li> <li>● Steady red: The port is faulty.</li> <li>● Off: The link to the port is down.</li> </ul>

### 4.3.2.3 Power Module

Power modules can ensure that the disk enclosure works correctly in maximum power consumption mode.

### Appearance

[Figure 4-30](#) shows the appearance of an AC power module.



**Figure 4-30** AC power module

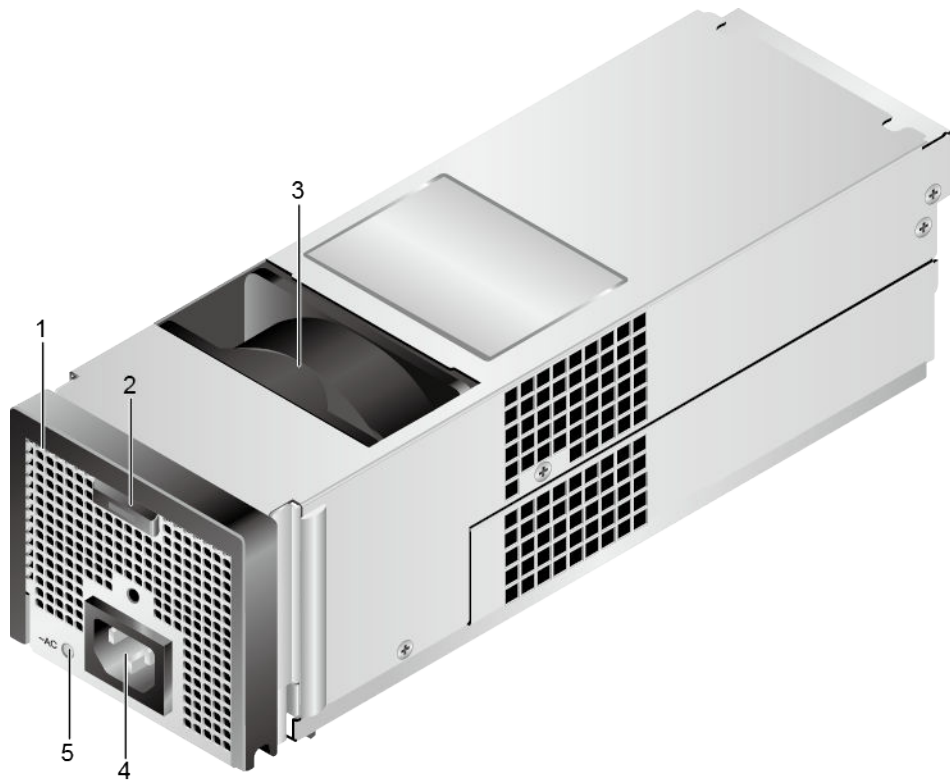

1	Power module handle	2	Power module latch
3	Fan built in the power module	4	Power module socket
5	Running/Alarm indicator of the power module		

## Indicators

**Table 4-13** describes indicators on a power module of a powered-on storage system.

**Table 4-13** Indicators on a power module

No.	Indicator	Status and Description
5	Running/Alarm indicator of the power module	<ul style="list-style-type: none"> <li>● Steady green: The power supply is correct.</li> <li>● Blinking green: The power input is normal but the disk enclosure is powered off.</li> <li>● Steady red: The power module is faulty.</li> <li>● Off: No external power input is found.</li> </ul>

### 4.3.2.4 Disk Module

Disk modules provide storage capacity for a storage system. Disk modules can function as system coffer disks to save service data, system data, and cache data.

#### Appearance

Figure 4-31 shows the appearance of a disk module.

Figure 4-31 Disk module

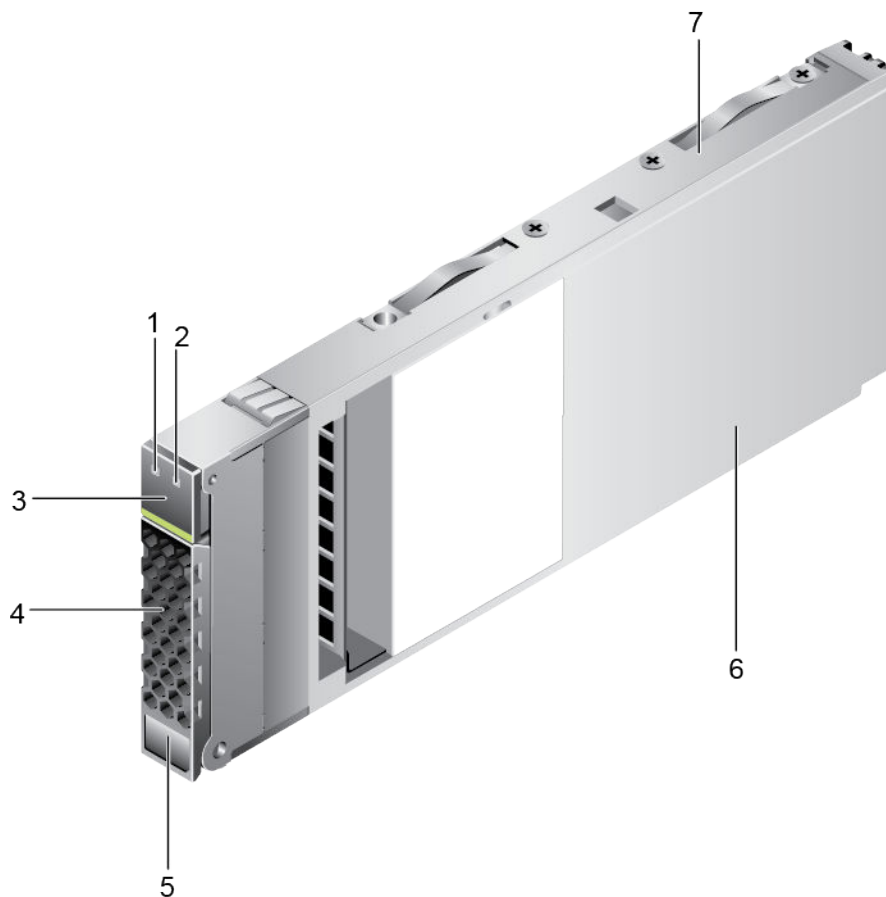

1	Running indicator of the disk module	2	Alarm/Location indicator of the disk module
3	Disk module latch	4	Disk module handle
5	Disk module label	6	Disk
7	Disk tray	-	-

#### Indicators

Table 4-14 describes indicators on a disk module of a powered-on storage system.

**Table 4-14** Indicators on a disk module

No.	Indicator	Status and Description
1	Running indicator of the disk module	<ul style="list-style-type: none"> <li>● Steady green: The disk module is working correctly.</li> <li>● Blinking green: Data is being read and written on the disk module.</li> <li>● Off: The disk module is powered off or powered on incorrectly.</li> </ul>
2	Alarm/Location indicator of the disk module	<ul style="list-style-type: none"> <li>● Steady red: The disk module is faulty.</li> <li>● Blinking red: The disk module is being located.</li> <li>● Off: The disk module is working correctly or hot swappable.</li> </ul>

### 4.3.3 Indicator Introduction

After a disk enclosure is powered on, you can check the current operating status of the disk enclosure by viewing its indicators.

#### Indicators on the Front Panel

**Figure 4-32** shows the indicators on the front panel of a disk enclosure.

**Figure 4-32** Indicators on the front panel of a disk enclosure

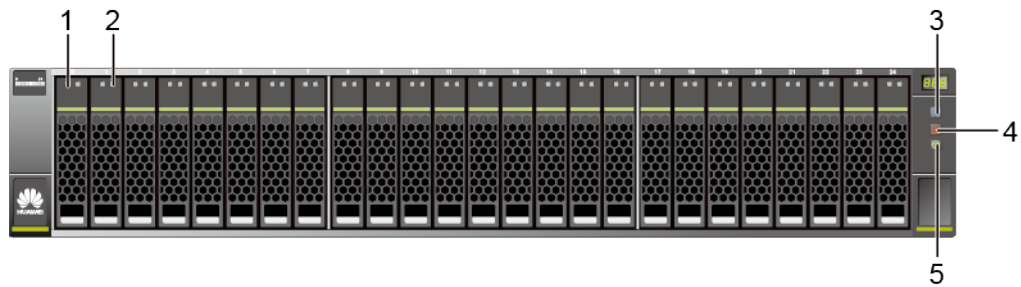

1	Running indicator of the disk module	2	Alarm/Location indicator of the disk module
3	Location indicator of the disk enclosure	4	Alarm indicator of the disk enclosure
5	Power indicator of the disk enclosure	-	-

**Table 4-15** describes the indicators on the front panel of the disk enclosure.

**Table 4-15** Description of the indicators on the front panel of a disk enclosure

Module	No.	Indicator	Status and Description
Disk module	1	Running indicator of the disk module	<ul style="list-style-type: none"> <li>● Steady green: The disk module is working correctly.</li> <li>● Blinking green: Data is being read and written on the disk module.</li> <li>● Off: The disk module is powered off or powered on incorrectly.</li> </ul>
	2	Alarm/Location indicator of the disk module	<ul style="list-style-type: none"> <li>● Steady red: The disk module is faulty.</li> <li>● Blinking red: The disk module is being located.</li> <li>● Off: The disk module is working correctly or hot swappable.</li> </ul>
System subrack	3	Location indicator of the disk enclosure	<ul style="list-style-type: none"> <li>● Blinking blue: The disk enclosure is being located.</li> <li>● Off: The disk enclosure is not located.</li> </ul>
	4	Alarm indicator of the disk enclosure	<ul style="list-style-type: none"> <li>● Steady red: An alarm is generated in the disk enclosure.</li> <li>● Off: The disk enclosure is working correctly.</li> </ul>
	5	Power indicator of the disk enclosure	<ul style="list-style-type: none"> <li>● Steady green: The disk enclosure is powered on.</li> <li>● Off: The disk enclosure is powered off.</li> </ul>

## Indicators on the Rear Panel

Figure 4-33 shows the indicators on the rear panel of a disk enclosure.

**Figure 4-33** Indicators on the rear panel of a disk enclosure

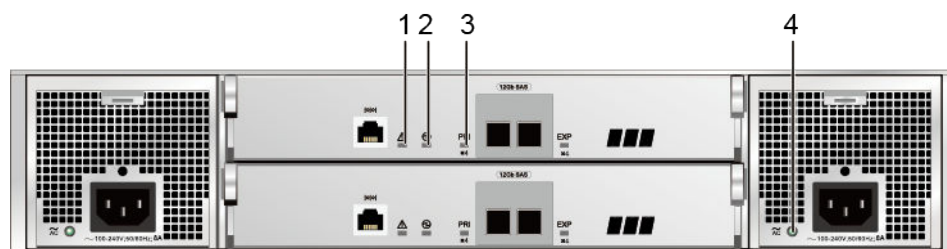

1	Alarm indicator of the expansion module	2	Power indicator of the expansion module
3	Indicator of the mini SAS HD expansion port	4	Running/Alarm indicator of the power/fan module

**Table 4-16** describes the indicators on the rear panel of the disk enclosure.

**Table 4-16** Description of the indicators on the rear panel of a disk enclosure

Module	No.	Indicator	Status and Description
Expansion module	1	Alarm indicator of the expansion module	<ul style="list-style-type: none"> <li>● Steady red: An alarm is generated on the expansion module.</li> <li>● Off: The expansion module is working correctly.</li> </ul>
	2	Power indicator of the expansion module	<ul style="list-style-type: none"> <li>● Steady green: The expansion module is powered on.</li> <li>● Off: The expansion module is powered off.</li> </ul>
	3	Indicator of the mini SAS HD expansion port	<ul style="list-style-type: none"> <li>● Steady blue: Data is transferred to the downstream disk enclosure at the rate of 4 x 12 Gbit/s.</li> <li>● Steady green: Data is transferred to the downstream disk enclosure at the rate of 4 x 3 Gbit/s or 4 x 6 Gbit/s.</li> <li>● Steady red: The port is faulty.</li> <li>● Off: The link to the port is down.</li> </ul>
Power module	4	Running/Alarm indicator of the power/fan module	<ul style="list-style-type: none"> <li>● Steady green: The power module and fan module are normal.</li> <li>● Blinking green: The power input is normal but the device is powered off.</li> <li>● Steady red: The power module or fan module is faulty.</li> <li>● Off: No external power input is found.</li> </ul>

## 4.4 4 U Disk Enclosure (3.5-Inch Disks)

This section describes a disk enclosure in terms of its hardware structure, component functions, front and rear views, and indicators.

## 4.4.1 Overview

The disk enclosure consists of a system subrack, expansion modules, power modules, fan modules, and disk modules.

### Overall Structure

Figure 4-34 shows the overall structure of a 4 U disk enclosure.

Figure 4-34 Overall structure of a 4 U disk enclosure

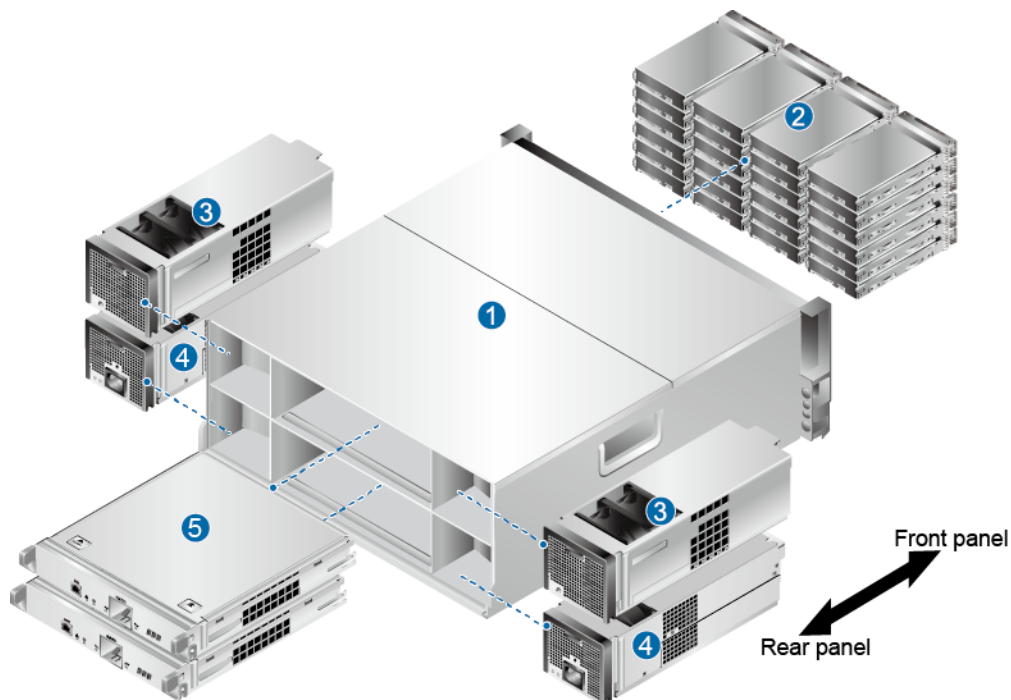

1	System subrack	2	Disk module
3	Fan module	4	Power module
5	Expansion module	-	-

### Front View

Figure 4-35 shows the front view of a 4 U disk enclosure.

**Figure 4-35** Front view of a 4 U disk enclosure

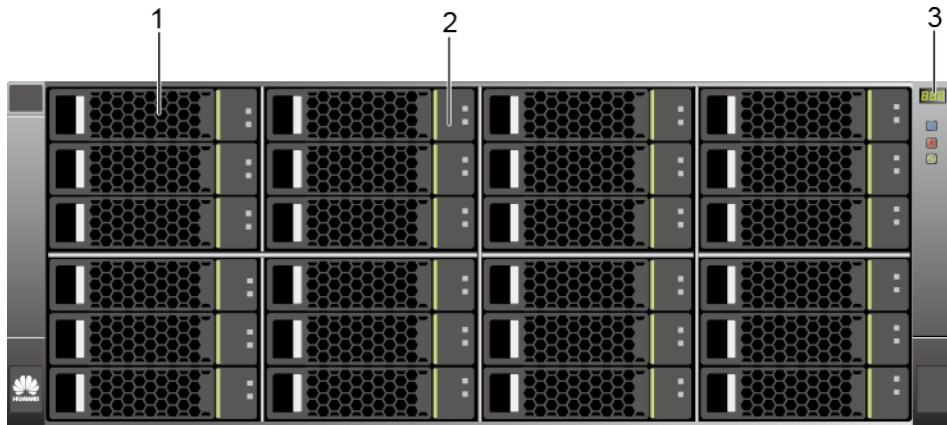

1	Disk module handle	2	3.5-inch disk module latch
3	ID display of the disk enclosure		

**NOTE**

The disk slots of a 4 U disk enclosure are numbered 0 to 23 from left to right and from top to bottom.

**Rear View**

**Figure 4-36** shows the rear view of a disk enclosure with the AC power module.

**Figure 4-36** Rear view of a disk enclosure with the AC power module

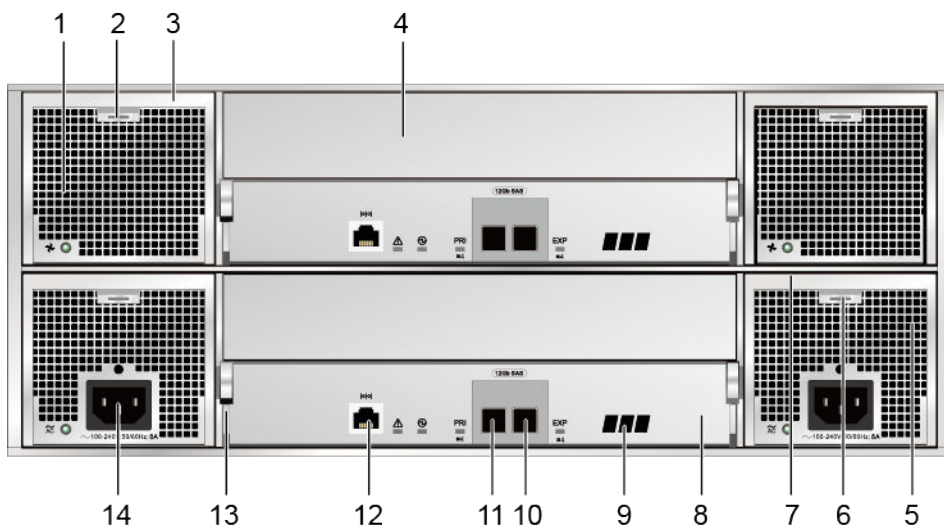

1	Fan module	2	Fan module latch
---	------------	---	------------------

3	Fan module handle	4	Filler panel
5	Power module	6	Power module latch
7	Power module handle	8	Expansion module
9	Disk enclosure ID display	10	Mini SAS HD EXP expansion port
11	Mini SAS HD PRI expansion port	12	Serial port
13	Expansion module handle	14	Power socket

## 4.4.2 Component Description

This section provides the detailed illustration and description for each component.

### 4.4.2.1 System Subrack

The system subrack houses a midplane to provide reliable connections for interface modules and to distribute power and signals to inner modules.

### Appearance

**Figure 4-37** shows the appearance of a system subrack.

**Figure 4-37** System subrack

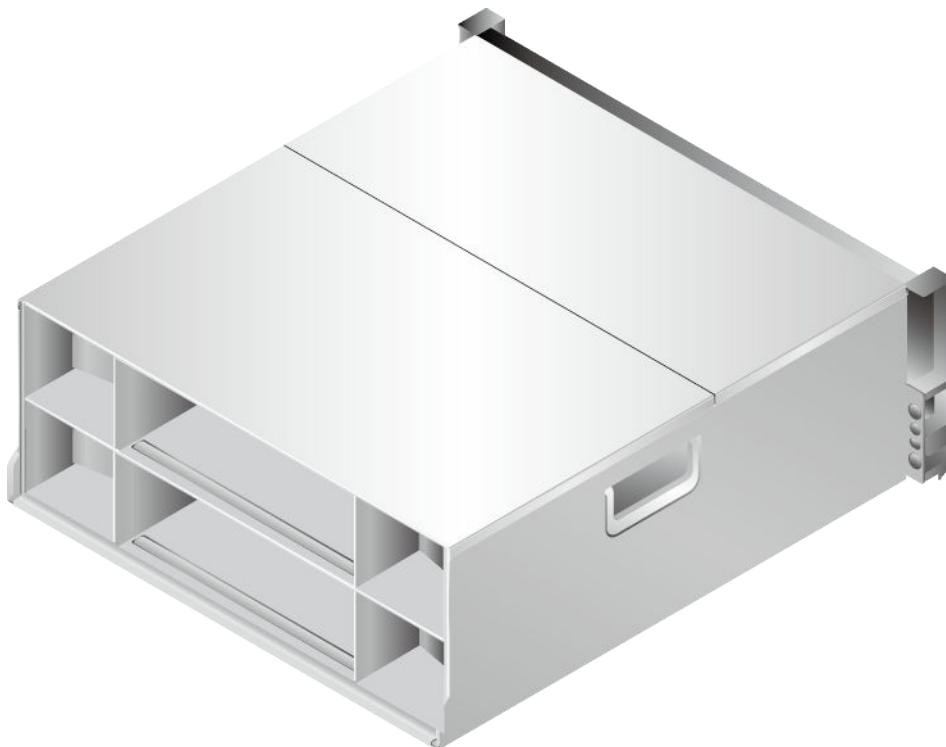



### 4.4.2.2 Expansion Module

An expansion module provides expansion ports for communication between the disk enclosure and the controller enclosure. Each expansion module provides a PRI expansion port and an EXP expansion port.

#### Appearance

Figure 4-38 shows the appearance of an expansion module.

Figure 4-38 Expansion module



#### Ports

Figure 4-39 shows the ports of an expansion module.

Figure 4-39 Interfaces of an expansion module

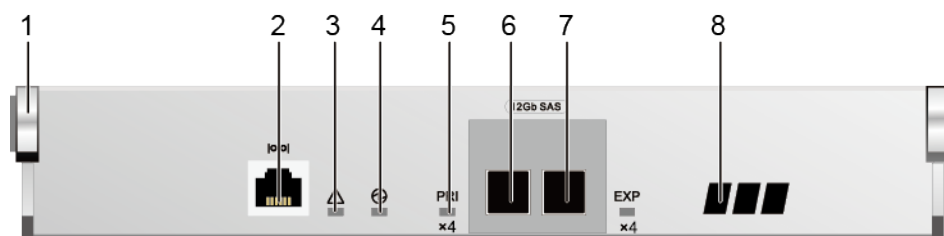

1	Expansion module handle	2	Serial port
---	-------------------------	---	-------------

3	Alarm indicator of the expansion module	4	Power indicator of the expansion module
5	Indicator of the mini SAS HD expansion port	6	Mini SAS HD PRI expansion port
7	Mini SAS HD EXP expansion port	8	Disk enclosure ID display

## Indicators

**Table 4-17** describes indicators on an expansion module of a powered-on storage system.

**Table 4-17** Indicators on an expansion module

No.	Indicator	Status and Description
3	Alarm indicator of the expansion module	<ul style="list-style-type: none"> <li>● Steady red: An alarm is generated in the expansion module.</li> <li>● Off: The expansion module is working correctly.</li> </ul>
4	Power indicator of the expansion module	<ul style="list-style-type: none"> <li>● Steady green: The expansion module is powered on.</li> <li>● Off: The expansion module is powered off.</li> </ul>
5	Indicator of the mini SAS HD expansion port	<ul style="list-style-type: none"> <li>● Steady blue: Data is transferred to the downstream disk enclosure at the rate of 4 x 12 Gbit/s.</li> <li>● Steady green: Data is transferred to the downstream disk enclosure at the rate of 4 x 3 Gbit/s or 4 x 6 Gbit/s.</li> <li>● Steady red: The port is faulty.</li> <li>● Off: The link to the port is down.</li> </ul>

### 4.4.2.3 Power Module

Power modules can ensure that the disk enclosure works correctly in maximum power consumption mode.

## Appearance

**Figure 4-40** shows the appearance of an AC power module.

**Figure 4-40** AC power module

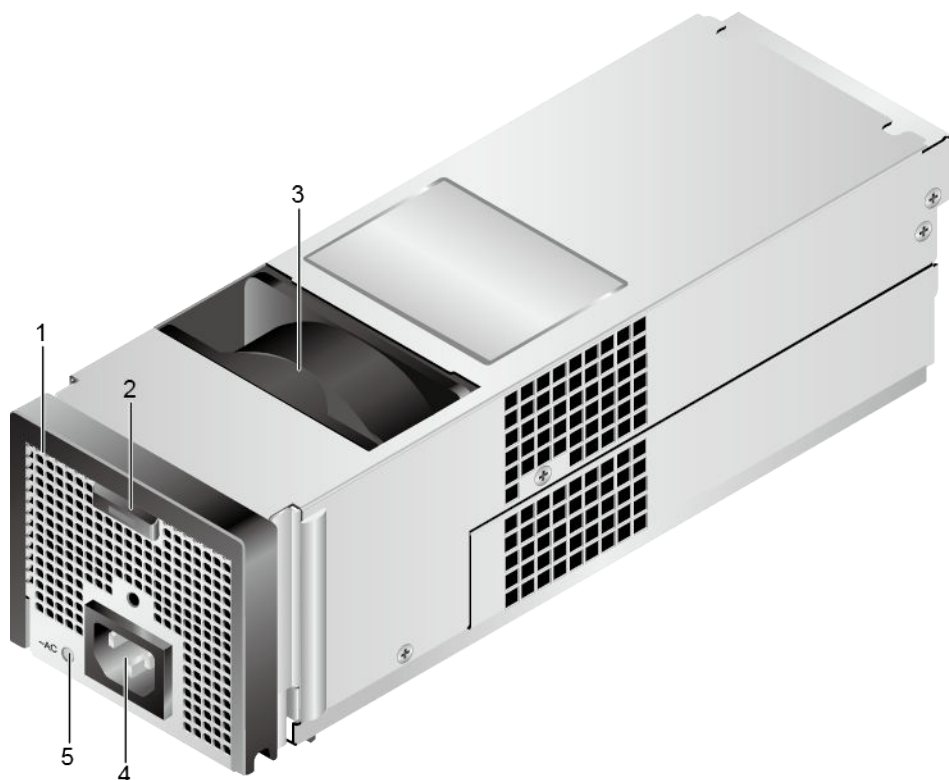

1	Power module handle	2	Power module latch
3	Fan built in the power module	4	Power module socket
5	Running/Alarm indicator of the power module		

## Indicators

**Table 4-18** describes indicators on a power module of a powered-on storage system.

**Table 4-18** Indicators on a power module

No.	Indicator	Status and Description
5	Running/Alarm indicator of the power module	<ul style="list-style-type: none"> <li>● Steady green: The power supply is correct.</li> <li>● Blinking green: The power input is normal but the disk enclosure is powered off.</li> <li>● Steady red: The power module is faulty.</li> <li>● Off: No external power input is found.</li> </ul>

### 4.4.2.4 Fan Module

A fan module provides heat dissipation and supports the normal running of the disk enclosure in maximum power consumption mode.

#### Appearance

Figure 4-41 shows the appearance of a fan module.

Figure 4-41 Fan module

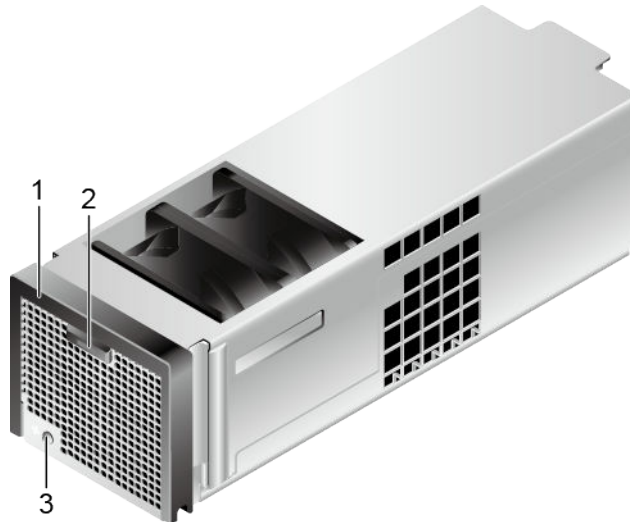

1	Fan module handle	2	Fan module latch
3	Running/Alarm indicator of the fan module	-	-

#### Indicators

Table 4-19 describes indicators on a fan module of a powered-on storage system.

Table 4-19 Indicators on a fan module

No.	Indicator	Status and Description
3	Running/Alarm indicator of the fan module	<ul style="list-style-type: none"> <li>● Steady green: The fan module is working correctly.</li> <li>● Steady red: The fan module is faulty.</li> <li>● Off: The fan module is powered off.</li> </ul>

### 4.4.2.5 Disk Module

Disk modules provide storage capacity for a storage system to store service data and can function as system coffer disks.

#### Appearance

Figure 4-42 shows the appearance of a disk module.

Figure 4-42 Disk module

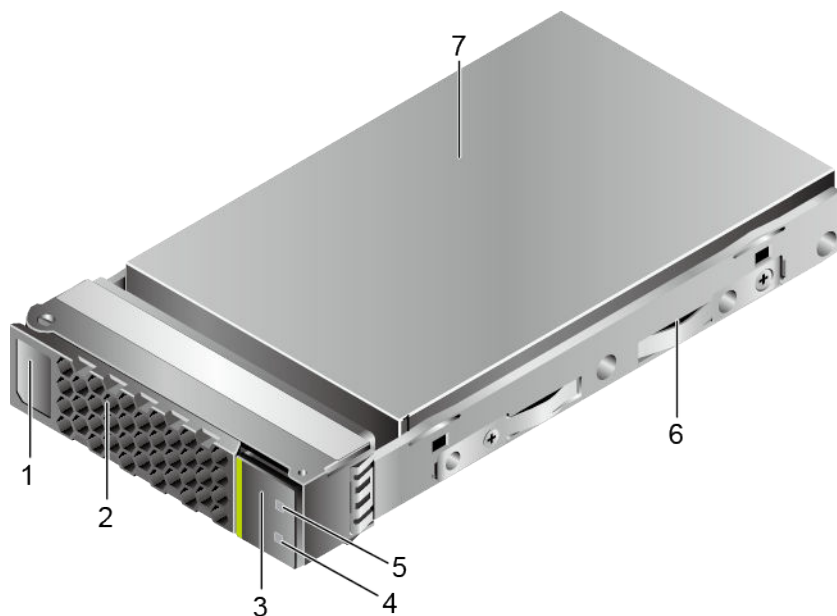

1	Disk module label	2	Disk module handle
3	Disk module latch	4	Alarm/Location indicator of the disk module
5	Running indicator of the disk module	6	Disk tray
7	Disk	-	-

#### Indicators

Table 4-20 describes indicators on a disk module of a powered-on storage system.

**Table 4-20** Indicators on a disk module

No.	Indicator	Status and Description
4	Alarm/Location indicator of the disk module	<ul style="list-style-type: none"> <li>● Steady red: The disk module is faulty.</li> <li>● Blinking red: The disk module is being located.</li> <li>● Off: The disk module is working correctly or hot swappable.</li> </ul>
5	Running indicator of the disk module	<ul style="list-style-type: none"> <li>● Steady green: The disk module is working correctly.</li> <li>● Blinking green: Data is being read and written on the disk module.</li> <li>● Off: The disk module is powered off or powered on incorrectly.</li> </ul>

### 4.4.3 Indicator Introduction

After a disk enclosure is powered on, you can check the current operating status of the disk enclosure by viewing its indicators.

#### Indicators on the Front Panel

**Figure 4-43** shows the indicators on the front panel of a disk enclosure.

**Figure 4-43** Indicators on the front panel of a disk enclosure

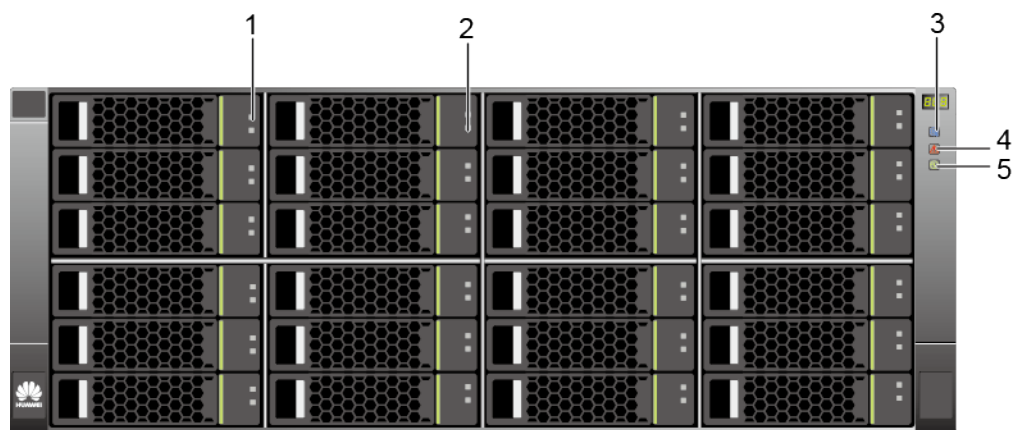

1	Running indicator of the disk module	2	Location/Alarm indicator of the disk module
3	Location indicator of the disk enclosure	4	Alarm indicator of the disk enclosure

5	Power indicator of the disk enclosure	-	-
---	---------------------------------------	---	---

**Table 4-21** describes the indicators on the front panel of the disk enclosure.

**Table 4-21** Description of the indicators on the front panel of a disk enclosure

Module	No.	Indicator	Status and Description
Disk module	1	Running indicator of the disk module	<ul style="list-style-type: none"> <li>● Steady green: The disk module is working correctly.</li> <li>● Blinking green: Data is being read and written on the disk module.</li> <li>● Off: The disk module is powered off or powered on incorrectly.</li> </ul>
	2	Alarm/Location indicator of the disk module	<ul style="list-style-type: none"> <li>● Steady red: The disk module is faulty.</li> <li>● Blinking red: The disk module is being located.</li> <li>● Off: The disk module is working correctly or hot swappable.</li> </ul>
System subrack	3	Location indicator of the disk enclosure	<ul style="list-style-type: none"> <li>● Blinking blue: The disk enclosure is being located.</li> <li>● Off: The disk enclosure is not located.</li> </ul>
	4	Alarm indicator of the disk enclosure	<ul style="list-style-type: none"> <li>● Steady red: An alarm is generated in the disk enclosure.</li> <li>● Off: The disk enclosure is working correctly.</li> </ul>
	5	Power indicator of the disk enclosure	<ul style="list-style-type: none"> <li>● Steady green: The disk enclosure is powered on.</li> <li>● Off: The disk enclosure is powered off.</li> </ul>

## Indicators on the Rear Panel

**Figure 4-44** shows the indicators on the rear panel of a disk enclosure.

**Figure 4-44** Indicators on the rear panel of a disk enclosure

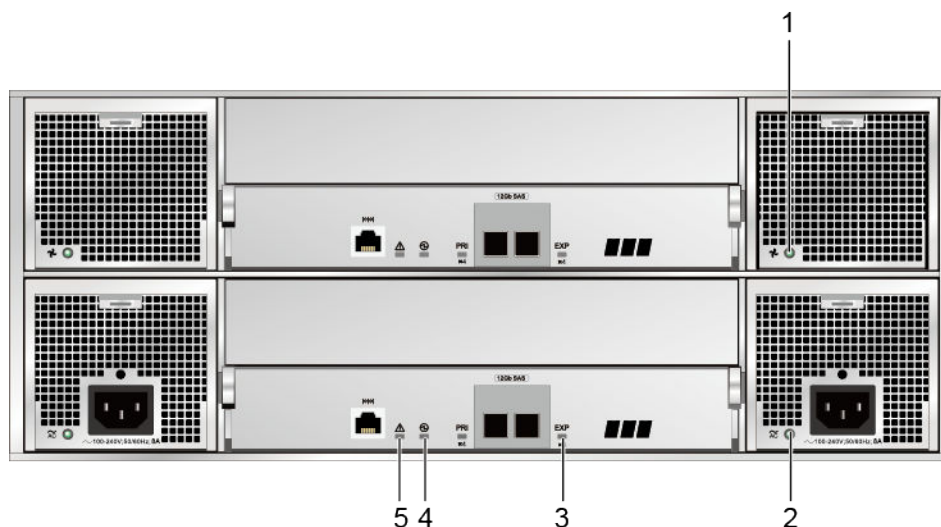

1	Running/Alarm indicator of the fan module	2	Running/Alarm indicator of the power module
3	Mini SAS HD expansion port indicator	4	Power indicator of the expansion module
5	Alarm indicator of the expansion module	-	-

**Table 4-22** describes the indicators on the rear panel of the disk enclosure.

**Table 4-22** Description of the indicators on the rear panel of a disk enclosure

Module	No.	Indicator	Status and Description
Fan module	1	Running/Alarm indicator of the fan module	<ul style="list-style-type: none"> <li>● Steady green: The fan module is working correctly.</li> <li>● Steady red: The fan module is faulty.</li> <li>● Off: The fan module is powered off.</li> </ul>
Power module	2	Running/Alarm indicator of the power/fan module	<ul style="list-style-type: none"> <li>● Steady green: The power module and fan module are normal.</li> <li>● Blinking green: The power input is normal but the device is powered off.</li> <li>● Steady red: The power module or fan module is faulty.</li> <li>● Off: No external power input is found.</li> </ul>



Module	No.	Indicator	Status and Description
Expansion module	3	Indicator of the mini SAS HD expansion port	<ul style="list-style-type: none"> <li>● Steady blue: Data is transferred to the downstream disk enclosure at the rate of 4 x 12 Gbit/s.</li> <li>● Steady green: Data is transferred to the downstream disk enclosure at the rate of 4 x 3 Gbit/s or 4 x 6 Gbit/s.</li> <li>● Steady red: The port is faulty.</li> <li>● Off: The link to the port is down.</li> </ul>
	4	Power indicator of the expansion module	<ul style="list-style-type: none"> <li>● Steady green: The expansion module is powered on.</li> <li>● Off: The expansion module is powered off.</li> </ul>
	5	Alarm indicator of the expansion module	<ul style="list-style-type: none"> <li>● Steady red: An alarm is generated on the expansion module.</li> <li>● Off: The expansion module is working correctly.</li> </ul>

## 4.5 Coffer Disk

The storage system has two kinds of coffer disks: built-in coffer disk and external coffer disk. Coffers disks are used to store three types of data: cache data requiring power failure protection, OceanStor OS system data, and system configuration information and logs.

### Built-in Coffers Disk

Each controller houses one or more disks as coffer disks. [Table 4-23](#) describes capacity partitions of the built-in coffer disks.

**Table 4-23** Capacity partitions of built-in coffer disks

Built-in Coffers Disk	8 GB per Controller	16 GB per Controller	Description
Size	1 x 16 GB SSD	2 x 16 GB SSDs	-
Cache dirty data partition	4.5 GB		Stores the cache dirty data that has not been written into a disk when the storage system is powered off.
OS system partition	6 GB		Stores the OceanStor OS system data.

Built-in Coffer Disk	8 GB per Controller	16 GB per Controller	Description
CCDB partition	1.4 GB		Stores the user configuration information (such as user configuration data of remote replication, HyperMetro, and NAS data).
LogZone partition	400 MB		Stores system logs and run logs when the storage system is powered off and write through is enabled.
DB partition	300 MB		Stores the user configuration information (such as information about the LUN capacity, ID, WWN, Fibre Channel ports, and iSCSI ports).

## External Coffer Disk

The first four disks in the storage system are configured as coffer disks. SAS, NL-SAS, or SSD disks can be used as coffer disks. The type of the four coffer disks must be the same.

### Appearance

Figure 4-45 and Figure 4-46 show the appearance of a coffer disk.

Figure 4-45 2.5-inch coffer disk

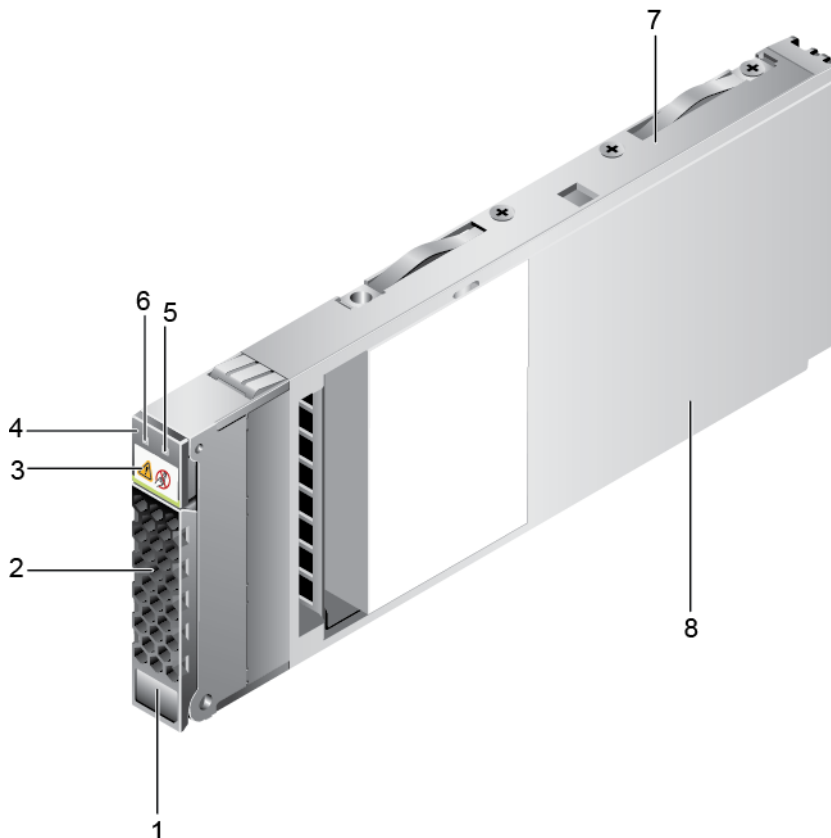
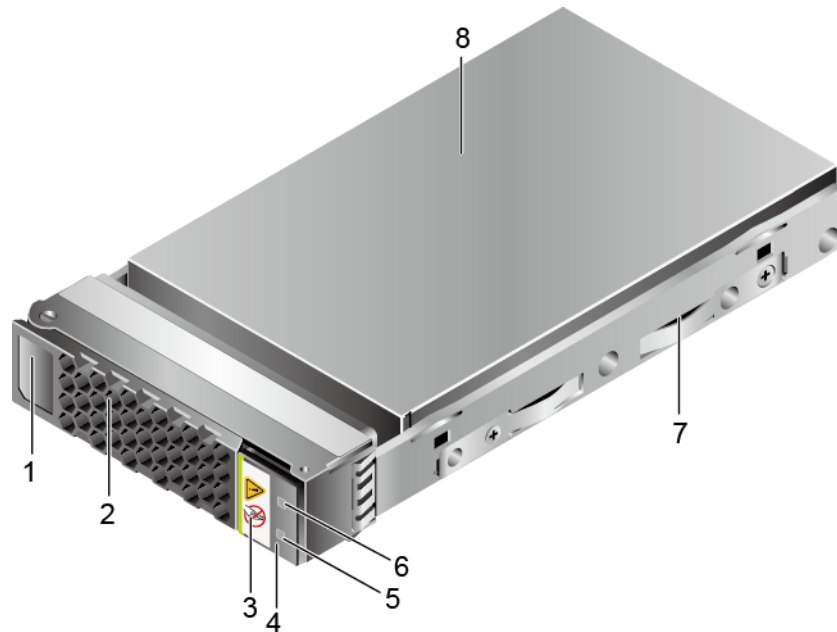

Figure 4-46 3.5-inch coffer disk



1	Disk module label	2	Disk module handle
3	Coffer disk label	4	Disk module latch
5	Alarm/Location indicator of the disk module	6	Running indicator of the disk module
7	Disk tray	8	Disk

### Positions

The first four disks in the storage system are configured as coffer disks. [Figure 4-47](#) uses a 2 U controller enclosure with 25 disk slots as an example.

Figure 4-47 Positions of external coffer disks

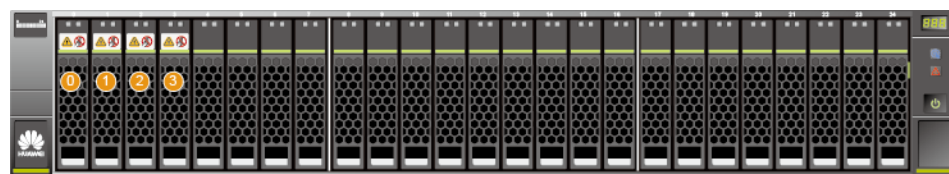

**Capacity partitions:** For the four disks, each spares 5 GB of space to form a RAID 1 group. The rest of the coffer disk space can be used to store service data. [Table 4-24](#) describes capacity partitions of external coffer disks.

**Table 4-24** Description of external coffer disk capacity partitions

Partition Name	Partition Size	Description
CCDB partition	2 GB	Stores the user configuration information (such as user configuration data of remote replication, HyperMetro, and NAS data). The four coffer disks are mirrors of each other for redundancy.
LogZone partition	2 GB	Stores system logs and run logs when the storage system is powered off and write through is enabled. The four coffer disks are mirrors of each other for redundancy.
DB partition	1 GB	Stores the user configuration information (such as information about the LUN capacity, ID, WWN, Fibre Channel ports, and iSCSI ports). The four coffer disks are mirrors of each other for redundancy.

## 4.6 Device Cables

Device cables used in the storage system include power cables, ground cables, and signal cables. This section displays their appearances and describes the functions and specifications of various cables.

### 4.6.1 Power Cables

Power cables are classified into AC power cables and PDU power cables. Power cables supply power to devices in a cabinet. One end of a power cable is connected to the power socket of the storage system, and the other end to an external power supply.

#### AC Power cable

Each AC power module is equipped with one AC power cable. Power cables supply power to devices in a cabinet. One end of a power cable is connected to the power socket of a device, and the other end to an external power supply. [Figure 4-48](#) shows the appearance of an AC power cable.

**Figure 4-48** AC power cable



## PDU Power cable

If a cabinet is equipped with power distribution units (PDUs), use PDU power cables to supply power to devices in the cabinet. [Figure 4-49](#) shows the appearance of a PDU power cable.

**Figure 4-49** PDU power cable



## 4.6.2 Ground Cables

Ground cables are used for device grounding to improve the security when you perform operations on a storage device.

### Appearance

[Figure 4-50](#) shows the appearance of a ground cable.

**Figure 4-50** Ground cable



## 4.6.3 Network Cables

The storage system uses network cables for its management network ports, service network ports, and other ports to connect to other devices or application servers for communication.

### Appearance

The storage system communicates with the external network using network cables. One end of the network cable connects to the management network port, service network port, or other maintenance network port of the storage system, and the other end connects to the network switch, application server, or other devices.

[Figure 4-51](#) shows the appearance of a network cable.

 **NOTE**

GE electrical ports employ CAT5 network cables or CAT6A shielded network cables. 10GE electrical ports employ 1 m to 3 m CAT6A shielded network cables.

**Figure 4-51** Network cable



## 4.6.4 Serial Cables

Serial cables are used to connect the serial ports of the storage system to other devices.

### Appearance

A serial cable connects the serial port of the storage system to the port of the maintenance terminal.

One end of a serial cable is the RJ-45 port used to connect to the serial port of a storage system. The other end is a DB-9 port used to connect to the port of the maintenance terminal.

[Figure 4-52](#) shows the appearance of a serial cable.

**Figure 4-52** Serial cable



## 4.6.5 Mini SAS HD Cables

Mini SAS HD cables are used to connect expansion ports. Mini SAS HD cables are divided into mini SAS HD electrical cables and mini SAS HD optical cables.

### NOTE

- For the lengths of the mini SAS HD electrical and optical cables, see the "Hardware Specifications".
- Use mini SAS HD electrical cables to connect controller enclosures to disk enclosures. It is recommended that a controller enclosure and its connected disk enclosure be installed in the same cabinet.
- The mini SAS HD optical cables can be used to connect devices over distance, for example, connections between disk enclosures across cabinets.
- The optical connector of a mini SAS HD optical cable has a built-in O/E conversion module and provides electrical ports.

### 4.6.5.1 Mini SAS HD Electrical Cables

Mini SAS HD electrical cables are used to connect a controller enclosure to a disk enclosure or connect two disk enclosures.

**Figure 4-53** shows the appearance of a mini SAS HD electrical cable.

**Figure 4-53** Mini SAS HD electrical cable



### 4.6.5.2 Mini SAS HD Optical Cables

Mini SAS HD optical cables are used to connect a controller enclosure to a standard disk enclosure or connect two standard disk enclosures.

**Figure 4-54** shows the appearance of a mini SAS HD optical cable.

 **NOTE**

The interface of a mini SAS HD optical cable is inconsistent with that of an optical fiber. Bind the mini SAS HD optical cable according to the cable binding method. For details about how to bind the mini SAS HD optical cable, see section "Cable Routing and Binding Basics" in *Installation Guide*.

**Figure 4-54** Mini SAS HD optical cable



## 4.6.6 Optical Fibers

The storage system communicates with Fibre Channel switches through optical fibers. One end of the optical fiber connects to the Fibre Channel host bus adapter (HBA), and the other end connects to the Fibre Channel switch or the application server. The two ends of the optical fiber are LC connectors.

**Figure 4-55** shows the appearance of optical fibers.

 **NOTE**

- Huawei provides orange OM1 optical fibers and blue OM3 and OM4 optical fibers.
- Huawei provides no longer than 10 m OM1 optical fibers.
- When connecting cables, select proper cables according to site requirements and label information.
- For details about how to bind the cables, see section "Cable Routing and Binding Basics" in *Installation Guide*.

**Figure 4-55** Optical fibers







# 5 Software Architecture

---

Storage system software manages storage devices and the data stored on them, and assists application servers in data operations.

The software suite provided by the OceanStor 2200 V3 storage system consists of software running on a storage system, software running on a maintenance terminal, and software running on an application server. These three types of software work jointly to deliver storage, backup, and disaster recovery services in a smart, efficient, and cost-effective manner.

**Figure 5-1** shows the storage system software architecture.

**Figure 5-1** Storage system software architecture

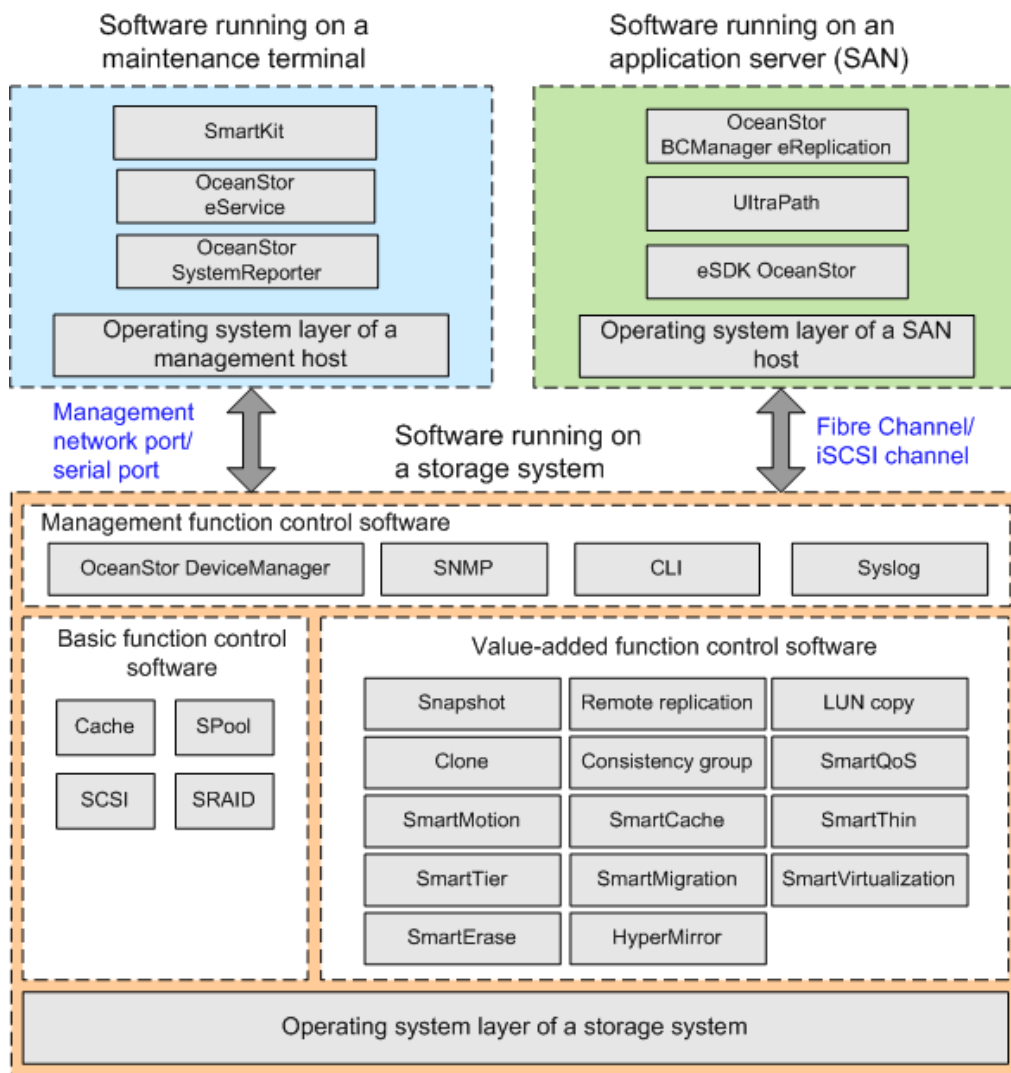

**Table 5-1** describes the software running on a storage system. The dedicated operating system OceanStor OS manages storage system hardware and supports the running of storage service software. The basic function control software provides basic data storage and access functions. The value-added function control software provides advanced functions such as backup, disaster recovery, and performance tuning. The management function control software provides the management utilities to the storage system.

**Table 5-1** Description of software running on a storage system

Software Set	Software	Function
Storage system operating system	-	Manages storage system hardware and supports the running of storage service software.

Software Set	Software	Function
Management function control software	DeviceManager	DeviceManager is an integrated storage management platform developed by Huawei. DeviceManager provides easy configuration, management, and maintenance of storage devices.
	SNMP <sup>ab</sup>	The storage system can be connected to third-party management software using the SNMP protocol. In addition, the storage system provides the functions supported by the third-party management software using the MIB interface. A variety of network management software supports SNMP. Users can choose the software based on their requirements.
	CLI <sup>c</sup>	The OceanStor 2200 V3 storage system supports CLI-based management and configuration. Users can use a third-party terminal software to log in to the OceanStor 2200 V3 storage system through its serial port or management network port (over SSH), and manage the storage system on the CLI.
	Syslog	The storage system can send alarm information to a third party. Syslog software is used to receive and save the information. Among various third-party Syslog software, users can choose one based on site requirements.
Basic function control software	SCSI software module	Manages the status of SCSI commands, and dispatches, resolves, and processes SCSI commands.
	Cache software module	Converts a high-speed and small-capacity memory to a buffer of low-speed and large-capacity disks for tiered storage and improved system performance. Its major functions include data caching, delayed writes, and prefetch.
	SRAID software module	Uses data stripping and redundancy to provide high performance, large capacity, and high reliability for data storage. A wide range of RAID levels are provided for diversified data reliability and access performance.

Software Set	Software	Function
	SPOOL software module	Logically combines disks from different disk enclosures into a disk domain, in which storage pools are created to provide storage resources for services.
Value-added function control software	SmartVirtualization software module	Provides the SmartVirtualization function. SmartVirtualization enables a local storage system to centrally manage storage resources of heterogeneous storage systems, simplifying storage system management and reducing maintenance costs.
	SmartErase software module	Provides the SmartErase function. SmartErase erases unnecessary data on a specified LUN several times so that the data on the LUN cannot be recovered in case of leakage.
	SmartCache software module	Provides SmartCache function, which uses SSDs as cache resources to significantly promote system read performance when random, small I/Os with hot data require more read operations than write operations.
	SmartQoS software module	Provides the SmartQoS function. SmartQoS controls the storage performance of LUNs or file systems, and prioritizes the quality of service (QoS) of critical applications.
	SmartMotion software module	Provides the SmartMotion function. Based on the analysis on service status, SmartMotion dynamically balances capacity and performance by evenly distributing data across storage media of the same type.
	SmartThin software module	Provides the SmartThin function. SmartThin achieves the on-demand space allocation. It allocates free storage space in quota to application servers only as needed, increasing the storage space usage.
	SmartTier software module	Provides the SmartTier function. SmartTier periodically detects hotspot data per unit time, and promotes them from low-speed storage media to high-speed one, boosting the system performance at an affordable cost.
	SmartMigration software module	Provides the SmartMigration function. SmartMigration migrates services on a source LUN transparently to a target LUN without interrupting host services. After the migration, the target LUN can replace the source LUN to carry the services.

Software Set	Software	Function
	HyperMirror module	Provides the HyperMirror function. HyperMirror backs up data in real time. If the source data becomes unavailable, applications can automatically use the data copy, ensuring high data security and application continuity.
	Snapshot software module	Provides the snapshot function. Snapshot does not provide a complete physical duplicate but only an image of the source data, and locates the image through a mapping table.
	Remote replication software module	Provides the remote replication function. Remote replication creates an available data duplicate almost in real time on a storage system that resides in a different region from the local storage system. The duplicate can be used immediately without data recovery, protecting service continuity and data availability to the maximum.
	LUN copy software module	Provides the LUN copy function. It copies the source LUN data onto the target LUN, addressing the requirements of applications such as tiered storage, application upgrade, and remote backup.
	Clone software module	Provides the clone function. Clone generates a full data copy of the source data in the local storage system.
	Consistency group software module	Provides the consistency group function. A consistency group manages remote replication tasks in batches. Any operation to the consistency group is also applied to the remote replication tasks in the group, ensuring data consistency throughout those remote replication tasks.
<p>a: Simple Network Management Protocol</p> <p>b: The supported character encoding is UTF-8.</p> <p>c: command line interface</p>		

**Table 5-2** describes the software running on a maintenance terminal. Maintenance terminal software configures and maintains the storage system. The software includes SmartKit, OceanStor SystemReporter, and OceanStor eService.

**Table 5-2** Description of software running on a maintenance terminal

Software	Function
SmartKit	SmartKit helps service engineers and O&M engineers deploy, maintain, and upgrade devices.
OceanStor eService	OceanStor eService is a piece of remote maintenance and management software used for device monitoring, alarm reporting, and device inspection.
OceanStor SystemReporter	OceanStor SystemReporter is a dedicated performance and capacity report analysis tool for the storage system.

**Table 5-3** describes the software running on an application server. On a SAN network, software running on an application server enables the application server to communicate and cooperate with the storage system. This software category includes BCManager eReplication, UltraPath, and eSDK OceanStor.

**Table 5-3** Description of software running on an application server (SAN)

Software	Function
BCManager eReplication	Provides data protection and disaster recovery for application servers based on the related storage system value-added features (synchronous/asynchronous remote replication, snapshot, LUN copy, clone, HyperMetro, and HyperVault). It centrally manages the requirements for data protection and disaster recovery between the storage system and application servers.
UltraPath	A storage system driver program installed on application servers. When multiple data channels are set up between an application server and a storage system, the UltraPath selects an optimal channel for the application server to access the storage system. Therefore, UltraPath is an easy and efficient path management solution for proven data transmission reliability and high path security.
eSDK OceanStor	eSDK OceanStor is a Huawei-developed integration platform for storage devices. It has open capabilities and provides standard interfaces and preinstalled plug-ins. The plug-ins and providers of eSDK OceanStor enable the storage system to interconnect network management platforms so that customers can use their existing network management systems to manage Huawei's storage devices.

# 6 Product Specifications

## About This Chapter

This chapter describes the hardware specifications and software specifications of the storage system.

[6.1 Hardware Specifications](#)

[6.2 Software Specifications](#)

## 6.1 Hardware Specifications

Hardware specifications cover the hardware configuration, port specifications, disk specifications, dimensions, weight, electrical specifications, and reliability specifications.

**Table 6-1** describes the hardware specification categories to help you quickly find out the specification information you need.

**Table 6-1** Description of hardware specification categories

Category	Description
<b>Hardware Configuration</b>	Describes the configuration of major hardware components, such as processors, memory capacity, disks, and ports.
<b>Port Specifications</b>	Describes the port specifications, such as the maximum number of ports provided by each type of interface module and the maximum number of interface modules supported by each controller.
<b>Disk Specifications</b>	Describes the dimensions, rotational speed, capacity, and weight of each type of disks.
<b>Dimensions and Weight (Unpacked)</b>	Describes the dimensions and weight of controller enclosures and disk enclosures.
<b>Electrical Specifications</b>	Describes the electrical specifications of controller enclosures and disk enclosures.



Category	Description
<b>Reliability Specifications</b>	Describes the reliability specifications of the storage system.

## Hardware Configuration

Item	Value
Processors per controller	1 x 16-core processor
Cache size per controller	<ul style="list-style-type: none"> <li>● 8 GB</li> <li>● 16 GB</li> </ul>
Maximum number of controllers per enclosure	2
Maximum number of IP Scale-out controllers	2
Maximum number of disks	300
Controller enclosure configuration	<ul style="list-style-type: none"> <li>● 2 U controller enclosure with twenty-five 2.5-inch disks</li> <li>● 2 U controller enclosure with twelve 3.5-inch disks</li> </ul>
Supported disk enclosure types	<ul style="list-style-type: none"> <li>● 2 U SAS disk enclosure with twenty-five 2.5-inch disks</li> <li>● 4 U SAS disk enclosure with twenty-four 3.5-inch disks</li> </ul>
Maximum number of disk enclosures	13
Maximum number of disk enclosures that can be connected to back-end channels (ports)	Up to 8 disk enclosures can be connected a SAS expansion port. Two is recommended.
Supported disk types	SSD, SAS, NL-SAS
Supported hot-swappable interface module types	<ul style="list-style-type: none"> <li>● 8 Gbit/s Fibre Channel</li> <li>● GE</li> <li>● 10GE (electrical)</li> <li>● 2-port SmartIO<sup>a</sup></li> <li>● 4-port SmartIO<sup>b</sup></li> </ul>
Maximum number of hot-swappable I/O interface modules per controller	<ul style="list-style-type: none"> <li>● 8 GB per controller: 1</li> <li>● 16 GB per controller: 2</li> </ul>

Item	Value
Length of expansion SAS cables	Controller enclosure <ul style="list-style-type: none"> <li>● Electrical cables: 1 m, 2 m, and 3 m</li> </ul> Disk enclosure <ul style="list-style-type: none"> <li>● Electrical cables: 1 m, 2 m, 3 m, and 5 m</li> <li>● Optical cable: 15 m</li> </ul>
Redundancy degree of main components	<ul style="list-style-type: none"> <li>● Backup power module: 1 (per controller)</li> <li>● Power modules: 1+1</li> <li>● Fans: 1+1</li> </ul>
a: SmartIO interface modules support various ports including 16 Gbit/s Fibre Channel ports, 10 Gbit/s FCoE (VN2VF) ports, 10 Gbit/s Ethernet ports. b: SmartIO interface modules support various ports including 8 Gbit/s Fibre Channel ports, 16 Gbit/s Fibre Channel ports, 10 Gbit/s FCoE (VN2VF) ports, 10 Gbit/s Ethernet ports (optical port, not negotiable to GE), and iWARP (interconnection between Scale-out nodes).	

## Port Specifications

Interface Module Type	Maximum Number of Ports per Interface Module
8-port 8 Gbit/s Fibre Channel interface module	Eight ports for each front-end module
GE electrical interface module	Four ports for each front-end module
10GE electrical interface module	Four ports for each front-end module
2-port SmartIO interface module	Two ports for each front-end module <sup>a</sup>
4-port SmartIO interface module	Four ports per module for each front-end or nodes-interconnection module <sup>b</sup>
a: SmartIO interface modules support various ports including 16 Gbit/s Fibre Channel ports, 10 Gbit/s FCoE (VN2VF) ports, 10 Gbit/s Ethernet ports. b: SmartIO interface modules support various ports including 8 Gbit/s Fibre Channel ports, 16 Gbit/s Fibre Channel ports, 10 Gbit/s FCoE (VN2VF) ports, 10 Gbit/s Ethernet ports (optical port, not negotiable to GE), and iWARP (interconnection between Scale-out nodes).	

Port Type	Max. Number of Ports per Controller
8 Gbit/s Fibre Channel port	8
16 Gbit/s Fibre Channel port	4

Port Type	Max. Number of Ports per Controller
GE port <sup>a</sup>	10 <sup>b</sup>
10GE port	4
10 Gbit/s FCoE port (VN2VF)	4
12 Gbit/s SAS expansion port <sup>c</sup>	2

a: Onboard front-end ports of the 2200 V3 are GE ports.  
b: includes two ports that can function as maintenance and service network ports, four onboard front-end ports, and four hot-swappable front-end ports.  
c: functions as the onboard back-end port.

## Disk Specifications

Disk Type <sup>a</sup>	Dimensions	Rotational Speed	Weight	Capacity
SAS	2.5-inch	10,000 rpm	0.25 kg (0.55 lb)	<ul style="list-style-type: none"> <li>● 600 GB<sup>b</sup></li> <li>● 900 GB</li> <li>● 1.2 TB<sup>b</sup></li> <li>● 1.8 TB<sup>b</sup></li> <li>● 2.4 TB</li> </ul>
		15,000 rpm	0.25 kg (0.55 lb)	600 GB
NL-SAS	3.5-inch	7200 rpm	0.725 kg (1.60 lb)	<ul style="list-style-type: none"> <li>● 2 TB</li> <li>● 4 TB<sup>b</sup></li> <li>● 6 TB<sup>b</sup></li> <li>● 8 TB</li> <li>● 10 TB<sup>b</sup></li> <li>● 12 TB</li> </ul>
SSD	2.5-inch	-	0.25 kg (0.55 lb)	<ul style="list-style-type: none"> <li>● 600 GB</li> <li>● 900 GB<sup>b</sup></li> <li>● 960 GB<sup>b</sup></li> <li>● 1.8 TB<sup>b</sup></li> <li>● 1.92 TB<sup>b</sup></li> <li>● 3.6 TB<sup>b</sup></li> <li>● 3.84 TB<sup>b</sup></li> <li>● 7.2 TB</li> <li>● 7.68 TB<sup>d</sup></li> </ul>

Disk Type <sup>a</sup>	Dimensions	Rotational Speed	Weight	Capacity
	3.5-inch		0.35 kg (0.77 lb)	<ul style="list-style-type: none"> <li>● 15.36 TB<sup>c</sup></li> <li>● 30.72 TB</li> </ul>
<p>a: Restricted by the storage principles, SSDs and mechanical disks such as NL-SAS and SAS disks cannot be preserved for a long term while they are powered off.</p> <ul style="list-style-type: none"> <li>● SSDs where no data is stored can be preserved for a maximum of 12 months while they are powered off. SSDs where data has been stored can be preserved for a maximum of 3 months while they are powered off. If the maximum preservation time is exceeded, data loss or SSD failure may occur.</li> <li>● Packed mechanical disks can be preserved for a maximum of six months. Unpacked mechanical disks that are powered off can be preserved for a maximum of six months too. If the maximum preservation time is exceeded, data loss or disk failure may occur. The maximum preservation time is determined based on the disk preservation specifications provided by the mechanical disk vendor. For details about the specifications, see the manual provided by the vendor.</li> </ul> <p>b: Self-encrypting disks (not sold in mainland China) are supported.</p> <p>c: 2.5-inch disks are supported.</p> <p>d: Self-encrypting disks (not sold in mainland China) and 2.5-inch disks are supported.</p>				

### Dimensions and Weight (Unpacked)

Module	Parameter	Value
Controller enclosure	Dimensions	<ul style="list-style-type: none"> <li>● Depth: 488 mm (19.21 in.)</li> <li>● Width: 447 mm (17.60 in.)</li> <li>● Height: 86.1 mm (3.39 in.)</li> </ul>
	Weight (without disks)	15.9 kg (35.05 lb)
2 U SAS disk enclosure	Dimensions	<ul style="list-style-type: none"> <li>● Depth: 488 mm (19.21 in.)</li> <li>● Width: 447 mm (17.60 in.)</li> <li>● Height: 86.1 mm (3.39 in.)</li> </ul>
	Weight (without disks)	13.3 kg (29.32 lb)
4 U SAS disk enclosure	Dimensions	<ul style="list-style-type: none"> <li>● Depth: 488 mm (19.21 in.)</li> <li>● Width: 447 mm (17.60 in.)</li> <li>● Height: 175 mm (6.89 in.)</li> </ul>
	Weight (without disks)	26.5 kg (58.42 lb)

## Electrical Specifications

Item		Value
Power consumption	Controller enclosure	12 disk slots <ul style="list-style-type: none"> <li>● Max: 393 W</li> <li>● Typical: 305 W</li> <li>● Min: 284 W</li> </ul> 25 disk slots <ul style="list-style-type: none"> <li>● Max: 429 W</li> <li>● Typical: 329 W</li> <li>● Minimum: 212 W</li> </ul>
	2 U disk enclosure	<ul style="list-style-type: none"> <li>● Max: 268 W</li> <li>● Typical: 215 W</li> <li>● Minimum: 205 W</li> </ul>
	4 U disk enclosure	<ul style="list-style-type: none"> <li>● Max: 472 W</li> <li>● Typical: 360 W</li> <li>● Minimum: 340 W</li> </ul>
Power voltage and rated current	Controller enclosure	<ul style="list-style-type: none"> <li>● AC: 100 V to 240 V, ±10%, 800 W, 10 A</li> <li>● High voltage DC (N/A for North America and Canada): 240 V, 800 W, 10 A</li> </ul>
	Disk enclosure	<ul style="list-style-type: none"> <li>● AC: 100 V to 240 V, ±10%, 800 W, 10 A</li> <li>● High voltage DC (N/A for North America and Canada): 240 V, 800 W, 10 A</li> </ul>
	AC power input type (socket type)	<ul style="list-style-type: none"> <li>● AC: IEC60320-C14</li> <li>● High voltage DC: IEC60320-C14</li> </ul>
Power supply by the backup power module		600 WS

## Reliability Specifications

Item	Value
Solution reliability	99.9999%
Mean Time Between Failures (MTBF)	1,000,000 hours
Mean Time To Repair (MTTR)	2 hours

## 6.2 Software Specifications

The software specifications include the basic specifications, feature specifications, performance specifications, supported operating systems, and license control.

**Table 6-2** describes the categories of the storage unit software specification to help you quickly find out the specification information you need.

**Table 6-2** Description of software specification categories

Category	Description
<b>Basic Specifications</b>	Describes the basic software specifications of the storage unit, including the maximum number of connected application servers, maximum number of LUNs, and maximum number of mapping views.
<b>Feature Specifications</b>	Describes the feature specifications of the storage unit.
<b>Supported Operating Systems</b>	Describes the operating systems supported by the storage unit.
<b>License Control</b>	Describes whether software features of the storage unit are controlled by licenses.

### Basic Specifications

Item	2200 V3 (8 GB per Controller)	2200 V3 (16 GB per Controller)
Maximum number of connected application servers	<ul style="list-style-type: none"> <li>● Fibre Channel ports: 1024</li> <li>● iSCSI ports: 256</li> </ul>	
Maximum number of hosts per host group	64	
RAID level	0, 1, 3, 5, 6, 10, or 50	
Maximum number of LUNs	512 <sup>a</sup>	
Maximum number of LUN groups	512	
Maximum number of LUNs that can be mapped to a host	255	
Maximum number of mapping views	1023	

Item	2200 V3 (8 GB per Controller)	2200 V3 (16 GB per Controller)
Maximum number of disk domains	8	
Maximum number of disks in a disk domain	300	
Minimum number of disks in a disk domain	4	
Maximum number of storage pools	8	
Maximum number of LUNs in a storage pool	512 <sup>a</sup>	
Minimum capacity of a LUN	512 KB	
Maximum capacity of a LUN	256 TB	
Maximum number of file systems	-	512
Minimum capacity of a file system	-	1 GB
Maximum capacity of a file system	-	16 PB
Maximum number of files per file system	-	2 billion
Maximum capacity of a file	-	256 TB
Maximum number of sub-directories per directory	-	30 million
Maximum number of SMB shares	-	12,000
Maximum number of NFS shares	-	10,000
Maximum number of CIFS and NFS connections per controller	-	11,000
Maximum number of FTP connections per controller	-	32
Maximum number of HTTP connections per controller	-	32

Item	2200 V3 (8 GB per Controller)	2200 V3 (16 GB per Controller)
Maximum NDMP flows per controller	-	8
Maximum number of local users	-	1000
Maximum number of local user groups	-	20,000
Maximum number of users in a user group	-	80,000
Maximum file path length	-	4096 bytes
Maximum length of a single file name or directory name	-	1024 bytes
Maximum directory depth of a file system	-	256
Maximum number of files that can be opened at a time on a controller	-	100,000
Maximum number of logical ports per controller	-	64
Maximum VLANs per controller	-	64
a: the maximum number of LUNs, writable LUN snapshots, and VVols (PE LUNs and VVol LUNs)		

## Feature Specifications

Feature	Parameter	2200 V3 (8 GB per Controller)	2200 V3 (16 GB per Controller)
HyperSnap	Maximum number of source LUNs	128	
	Maximum number of snapshots for a source LUN	64	
	Maximum number of LUN snapshots	256	



Feature	Parameter	2200 V3 (8 GB per Controller)	2200 V3 (16 GB per Controller)
	Maximum number of LUNs that can be batch activated	64	
	Maximum number of read-only snapshots in a file system	-	16000
	Maximum number of read-only snapshots for a source file system	-	2048
	Minimum interval of periodic snapshots for a file system	-	1 minute
	Recovery time of a file system snapshot	-	< 10 seconds
LUN copy	Maximum number of LUN copies	32	
	Maximum number of target LUNs for each source LUN	32	
LUN clone	Maximum number of primary LUNs	128	
	Maximum number of secondary LUNs	128	
	Maximum number of secondary LUNs in a clone group	8	
	Maximum number of consistent split pairs	64	
File system clone	Maximum number of clone file systems	-	512 (total number of clone file systems and file systems)
	Maximum levels of cascading clones	-	8
HyperReplication	Maximum number of pairs in a remote replication <sup>a</sup>	128 (synchronous + asynchronous)	

Feature	Parameter	2200 V3 (8 GB per Controller)	2200 V3 (16 GB per Controller)
	Maximum number of secondary LUNs in a pair	<ul style="list-style-type: none"> <li>● Synchronous: 1:1</li> <li>● Asynchronous: 1:2</li> </ul>	
	Maximum number of secondary file systems in a pair	-	Asynchronous: 1:1
	Maximum number of connected remote storage devices	32	
	Maximum number of pairs in a remote replication consistency group	32	
	Maximum number of remote replication consistency groups	32 (synchronous+asynchronous)	
	Maximum number of pairs in a remote replication <b>NOTE</b> Applicable to V300R006C10 and later.	-	63
SmartQoS	Maximum number of SmartQoS policies	128	
	Maximum number of LUNs supported by a policy	64	
	Number of priority levels	3	
SmartTier	Maximum number of tiers	3 (SSD/SAS/NL-SAS)	<ul style="list-style-type: none"> <li>● SAN: 3 (SSD/SAS/NL-SAS)</li> <li>● NAS: 2 (SSD/HDD, HDD including SAS and NL-SAS)</li> </ul>

Feature	Parameter	2200 V3 (8 GB per Controller)	2200 V3 (16 GB per Controller)
	Migration granularity (configurable)	512 KB, 1 MB, 2 MB, 4 MB, 8 MB, 16 MB, 32 MB, or 64 MB (4 MB by default)	<ul style="list-style-type: none"> <li>● SAN: 512 KB, 1 MB, 2 MB, 4 MB, 8 MB, 16 MB, 32 MB, or 64 MB (4 MB by default)</li> <li>● NAS: file size</li> </ul>
	Data migration speed	High/Medium/Low	<ul style="list-style-type: none"> <li>● SAN: High/Medium/Low</li> <li>● NAS: automatically (unconfigurable)</li> </ul>
SmartMotion	Granularity	64 MB	
SmartThin	Maximum number of thin LUNs	512	
	Maximum capacity of a thin LUN	256 TB	
	Conversion between thin LUNs and thick LUNs	Supported (implemented via LUN migration)	
	Granularity of a thin LUN	<ul style="list-style-type: none"> <li>● When SmartDedupe&amp;SmartCompression is not enabled, the value is fixed at 64 KB.</li> <li>● When SmartDedupe&amp;SmartCompression is enabled, the default value is 64 KB. The value can be adjusted to 4 KB/8 KB/16 KB/32 KB/64 KB on the CLI.</li> </ul>	
	Space reclaiming	Supported	
SmartMigration SmartMigration (SAN)	Maximum number of LUNs that can be simultaneously migrated by a controller	8	
	Maximum number of LUNs for which migration can be configured at a time	64	
	Maximum number of LUNs for which consistency split can be performed	64	

Feature	Parameter	2200 V3 (8 GB per Controller)	2200 V3 (16 GB per Controller)
SmartMigration (NAS) <sup>b</sup>	Maximum number of file systems that can be migrated simultaneously by each controller	-	16
	Number of file systems for which migration can be configured at a time	-	32
SmartErase	Maximum number of LUNs whose data can be simultaneously destroyed by each controller	8	
SmartMulti-Tenant	Maximum number of vStores	-	63
	Maximum number of vStore administrators	-	128
	Maximum number of vStore administrators for a tenant	-	32
SmartVirtualization	Maximum number of external LUNs	256	
	Maximum number of external storage arrays	32	
	Maximum number of paths for each external LUN	8	
	Maximum number of masqueraded external LUNs	512	
	Maximum number of external links that connect to arrays	256	

Feature	Parameter	2200 V3 (8 GB per Controller)	2200 V3 (16 GB per Controller)
	Maximum number of external links that connect to arrays on a controller	128	
HyperMirror	Maximum number of volume mirrors	64	
	Number of copies per volume mirror	2	
SmartQuota	Number of quota directory trees per file system	-	4096
	User quota	-	1000
	User group quota	-	20,000
SmartCache	Total SSD cache capacity per controller	200 GB (8 GB per controller)	400 GB (16 GB per controller)
	Number of SSD cache partitions for two controllers	8 user partitions and a default cache partition	
	Data block granularity of SSD cache	4 KB, 8 KB, 16 KB, 32 KB, 64 KB, or 128 KB auto-adjustable	
NAS antivirus	Virus-scanning mode	-	CIFS share (scanning starts when files are closed)
	Maximum number of antivirus servers	-	128
	Maximum number of file systems that can be monitored	-	512
	Maximum number of virus scanning policies	-	256
	Maximum number of antivirus servers per vStore	-	32
HyperVault	Maximum number of backup pairs	-	128

Feature	Parameter	2200 V3 (8 GB per Controller)	2200 V3 (16 GB per Controller)
	Maximum number of backup copies	-	1024
	Backup speed	-	Fast, high, medium, and low
	Backup period	-	5 minutes to 1 month
	Maximum number of backup policies per pair	-	Local backup policies: 4 Remote backup policies: 4
	Maximum number of backup copies per pair	-	Local backup copies: 256 Remote backup copies: 256
<p>a: total number of SAN HyperReplication pairs, NAS HyperReplication pairs, HyperVault pairs, and doubled NAS SmartMigration tasks</p> <p><b>NOTE</b> For V300R006C30 and later versions, intra-array asynchronous replication is supported. An intra-array asynchronous replication pair is displayed as two remote replication pairs and has the same specifications as those of two remote replication pairs.</p> <p>b: supported in V300R006C60 and later versions</p>			

## Supported Operating Systems

Only the common operating systems supported by the storage systems are listed. For details, contact Huawei technical support engineers.

Operating System	Version
Windows	<p>Mainstream Windows operating systems are supported, including but not limited to the following:</p> <ul style="list-style-type: none"> <li>● Windows Server 2003 R2 Standard SP2</li> <li>● Windows Server 2003 R2 Datacenter SP2</li> <li>● Windows Server 2003 R2 Enterprise Edition SP2</li> <li>● Windows Server 2008 R2 Standard SP1</li> <li>● Windows Server 2008 R2 Datacenter SP1</li> <li>● Windows Server 2008 R2 Enterprise Edition SP1</li> <li>● Windows Server 2012 Standard</li> <li>● Windows Server 2012 Datacenter</li> <li>● Windows Server 2012 Essentials</li> <li>● Windows Server 2012 Foundation X64 Edition</li> </ul>
Linux	<p>Mainstream Linux operating systems are supported, including but not limited to the following:</p> <ul style="list-style-type: none"> <li>● SUSE Linux Enterprise Server 10</li> <li>● SUSE Linux Enterprise Server 11</li> <li>● Red Hat Enterprise Server AS 5</li> <li>● Red Hat Enterprise Server AS 6</li> </ul>
Other mainstream operating systems	<ul style="list-style-type: none"> <li>● HP-UX 11i v2</li> <li>● HP-UX 11i v3</li> <li>● AIX 6.1</li> <li>● AIX 7.1</li> <li>● Solaris 10 for Sparc</li> <li>● Solaris 11 for Sparc</li> <li>● VMware ESXi 4.1</li> <li>● VMware ESXi 5.0</li> <li>● Citrix XenServer 5.6</li> <li>● Citrix XenServer 6.0</li> <li>● MAC OS X 10.7</li> <li>● Other mainstream operating systems</li> </ul>

## License Control

Function	Requiring License Control or Not
HyperSnap (Snapshot)	Yes <sup>ab</sup>
HyperClone (Clone)	Yes

Function	Requiring License Control or Not
HyperCopy (LUN Copy)	Yes
HyperReplication (Remote replication)	Yes <sup>bc</sup>
SmartQoS	Yes <sup>b</sup>
SmartTier	Yes
SmartMotion	Yes
SmartThin	Yes
SmartMigration	Yes
SmartErase	Yes
SmartVirtualization	Yes
HyperMirror	Yes
SmartCache	Yes <sup>b</sup>
SmartMulti-Tenant	Yes <sup>d</sup>
SmartQuota	Yes <sup>d</sup>
CIFS	Yes <sup>d</sup>
NFS	Yes <sup>d</sup>
WORM (HyperLock)	Yes <sup>d</sup>
NDMP	Yes <sup>d</sup>
HyperVault	Yes <sup>d</sup>
<p>a: HyperSnap for block and file services requires the same license. After importing the license file for the HyperSnap feature, a user can create snapshots for both block and file services.</p> <p>b: OceanStor 2200 V3 (8 GB memory per controller) does not support the file systems.</p> <p>c: HyperReplication for block and file services requires the same license. After importing the license file for the HyperReplication feature, a user can create remote replications for both block and file services.</p> <p>d: not supported by OceanStor 2200 V3 (8 GB memory per controller).</p>	

 **NOTE**

As the OceanStor SystemReporter and OceanStor UltraPath are not deployed on a storage system, you cannot check them on the license management page of the storage system. To view purchased features, you can obtain the product authorization certificate from your dealer, which shows the purchased features.



## Interoperability and Host Connectivity

You can go to [OceanStor Interoperability Navigator](#) and select the components such as an operating system and multipathing software you want to check to obtain the compatibility information.

# 7 Environmental Requirements

## About This Chapter

Environmental requirements cover the following aspects: temperature, humidity, particle contaminants, corrosive airborne contaminants, heat dissipation, and noise.

[7.1 Temperature, Humidity, and Altitude](#)

[7.2 Vibration and Shock](#)

[7.3 Particle Contaminants](#)

[7.4 Corrosive Airborne Contaminants](#)

[7.5 Heat Dissipation and Noise](#)

## 7.1 Temperature, Humidity, and Altitude

Temperature, humidity, and altitude requirements must be met so that storage systems can correctly work or be properly preserved.

**Table 7-1** lists the temperature, humidity, and altitude requirements of the storage systems.

**Table 7-1** Temperature, humidity, and altitude requirements of storage systems

Parameter	Condition	Requirement
Temperature	Operating temperature	<ul style="list-style-type: none"> <li>● 5°C to 40°C (41°F to 104°F) when the altitude is between -60 m and +1800 m (-196.85 ft. and +5905.51 ft.)</li> <li>● At altitudes between 1800 m and 3000 m (5905.51 ft. and 9842.52 ft.), the temperature drops by 1°C for 220 m (721.78 ft.) of altitude increase.</li> </ul>
	Temperature variation in the operating environment	1°C/min

Parameter	Condition	Requirement
	Non-operating ambient temperature	-40°C to +70°C (-40°F to +158°F)
	Storage temperature (during transportation and storage with packages)	-40°C to +70°C (-40°F to +158°F)
Humidity	Operating humidity	10% RH <sup>a</sup> to 90% RH
	Non-operating ambient humidity	5% RH to 95% RH
	Maximum humidity variation	10 %/h
	Storage humidity (during transportation and storage with packages)	5% RH to 95% RH
Altitude	Operating altitude of disks	<ul style="list-style-type: none"> <li>● HDDs: -304.8 m to +3048 m (-1000 ft. to +10000 ft.)</li> <li>● SSDs: -305 m to +3048 m (-1000.66 ft. to +10000 ft.)</li> </ul>
	Non-operating altitude of disks	<ul style="list-style-type: none"> <li>● HDDs: -305 m to +12192 m (-1000.66 ft. to +40000 ft.)</li> <li>● SSDs: -305 m to +12192 m (-1000.66 ft. to +40000 ft.)</li> </ul>
a: RH, Relative Humidity		

## 7.2 Vibration and Shock

Vibration and shock requirements must be met so that storage systems can work correctly or be properly preserved.

**Table 7-2** lists the vibration and shock requirements of storage systems.

**Table 7-2** Vibration and shock requirements of storage systems

Parameter	Requirement
Operating vibration	5 to 350 Hz, PSD: 0.0002 g <sup>2</sup> /Hz, 350 to 500 Hz, -3 dB, 0.3 Grms, axial direction: 3 axes

Parameter	Requirement
Non-operating vibration	10 to 500 Hz, 1.49 Grms, 3 axes, 15 min/axis PSD: <ul style="list-style-type: none"> <li>● 10 HZ@0.1g<sup>2</sup>/HZ</li> <li>● 20 HZ@0.1g<sup>2</sup>/HZ</li> <li>● 50 HZ@0.004g<sup>2</sup>/HZ</li> <li>● 100 HZ@0.001g<sup>2</sup>/HZ</li> <li>● 500 HZ@0.001g<sup>2</sup>/HZ</li> </ul>
Non-operating shock	Half sine, 70 Gs/2 ms, 1 shock/face, total 6 faces

## 7.3 Particle Contaminants

Particle contaminants and other negative environmental factors (such as abnormal temperature and humidity) may expose IT equipment to a higher risk of corrosive failure. This section specifies the limitation on particle contaminants with the aim at avoiding such risks.

The concentration level of particle contaminants in a data center should meet the requirements listed in the white paper entitled *Gaseous and Particulate Contamination Guidelines for Data Centers published in 2011* by the American Society of Heating Refrigerating and Air-conditioning Engineers (ASHRAE) Technical Committee (TC) 9.9.

ASHRAE, affiliated to International Organization for Standardization (ISO), is an international organization operated for the exclusive purpose of advancing the arts and sciences of heating, ventilation, air-conditioning, and refrigeration (HVAC & R).

According to the Guidelines, particle contaminants in a data center shall reach the cleanliness of ISO 14664-1 Class 8:

- Each cubic meter contains not more than 3,520,000 particles that are greater than or equal to 0.5 μm.
- Each cubic meter contains not more than 832,000 particles that are greater than or equal to 1 μm.
- Each cubic meter contains not more than 29,300 particles that are greater than or equal to 5 μm.

It is recommended that you use an effective filter to process air flowing into the data center as well as a filtering system to periodically clean the air already in the data center.

ISO 14644-1, Cleanrooms and Associated Controlled Environments - Part 1: Classification of Air Cleanliness, is the primary global standard on air cleanliness classification. [Table 7-3](#) gives the air cleanliness classification by particle concentration.

**Table 7-3** Air cleanliness classification by particle concentration of ISO 14664-1 and maximum allowable concentrations (particles/m<sup>3</sup>) for particles

ISO Class	Particle Size ≥ 0.1 μm	Particle Size ≥ 0.2 μm	Particle Size ≥ 0.3 μm	Particle Size ≥ 0.5 μm	Particle Size ≥ 1 μm	Particle Size ≥ 5 μm
Class 1	10	2	-	-	-	-
Class 2	100	24	10	4	-	-
Class 3	1000	237	102	35	8	-
Class 4	10,000	2370	1020	352	83	-
Class 5	100,000	23,700	10,200	3520	832	29
Class 6	1,000,000	237,000	102,000	35,200	8320	293
Class 7	-	-	-	352,000	83,200	2930
Class 8	-	-	-	3,520,000	832,000	29,300
Class 9	-	-	-	-	8,320,000	293,000

## 7.4 Corrosive Airborne Contaminants

Corrosive airborne contaminants and other negative environmental factors (such as abnormal temperature and humidity) may expose IT equipment to higher risks of corrosive failure. This article specifies the limitation on corrosive airborne contaminants with an aim at avoiding such risks.

**Table 7-4** lists common corrosive airborne contaminants and their sources.

**Table 7-4** Common corrosive airborne contaminants and their sources

Symbol	Sources
H <sub>2</sub> S	Geothermal emissions, microbiological activities, fossil fuel processing, wood rot, sewage treatment
SO <sub>2</sub> , SO <sub>3</sub>	Coal combustion, petroleum products, automobile emissions, ore smelting, sulfuric acid manufacture
S	Foundries, sulfur manufacture, volcanoes
HF	Fertilizer manufacture, aluminum manufacture, ceramics manufacture, steel manufacture, electronics device manufacture
NO <sub>x</sub>	Automobile emissions, fossil fuel combustion, chemical industry
NH <sub>3</sub>	Microbiological activities, sewage, fertilizer manufacture, geothermal emissions, refrigeration equipment

Symbol	Sources
C	Incomplete combustion (aerosol constituent), foundry
CO	Combustion, automobile emissions, microbiological activities, tree rot
Cl <sub>2</sub> , ClO <sub>2</sub>	Chlorine manufacture, aluminum manufacture, zinc manufacture, refuse decomposition
HCl	Automobile emissions, combustion, forest fire, oceanic processes, polymer combustion
HBr, HI	Automobile emissions
O <sub>3</sub>	Atmospheric photochemical processes mainly involving nitrogen oxides and oxygenated hydrocarbons
C <sub>N</sub> H <sub>N</sub>	Automobile emissions, animal waste, sewage, tree rot

The concentration level of corrosive airborne contaminants in a data center should meet the requirements listed in the white paper entitled *Gaseous and Particulate Contamination Guidelines for Data Centers published in 2011* by the American Society of Heating, Refrigerating and Air-conditioning Engineers (ASHRAE) Technical Committee (TC) 9.9.

According to the Guidelines, corrosive airborne contaminants in a data center should meet the following requirements:

- Copper corrosion rate  
Less than 300 Å/month per ANSI/ISA-71.04-1985 severity level G1.
- Silver corrosion rate  
Less than 200 Å/month.

 **NOTE**

Å, or angstrom, is a unit of length. One Å is equal to 1/10,000,000,000 meter.

According to ANSI/ISA-71.04-1985 Environmental Conditions for Process Measurement and Control Systems: Airborne Contaminants, the gaseous corrosivity levels are G1 (mild), G2 (moderate), G3 (harsh), and GX (severe), as described in [Table 7-5](#).

**Table 7-5** Gaseous corrosivity levels per ANSI/ISA-71.04-1985

Severity Level	Copper Reactivity Level	Description
G1 (mild)	300 Å/month	An environment sufficiently well-controlled such that corrosion is not a factor in determining equipment reliability.
G2 (moderate)	300 Å/month to 1000 Å/month	An environment in which the effects of corrosion are measurable and may be a factor in determining equipment reliability.

Severity Level	Copper Reactivity Level	Description
G3 (harsh)	1000 Å/month to 2000 Å/month	An environment in which there is high probability that corrosion will occur.
GX (severe)	> 2000 Å/month	An environment in which only specially designed and packaged equipment would be expected to survive.

See [Table 7-6](#) for the copper and silver corrosion rate requirements.

**Table 7-6** Concentration limitation of corrosive airborne contaminants in a data center

Group	Gas	Unit	Concentration
Group A	H <sub>2</sub> S	ppb <sup>a</sup>	< 3
	SO <sub>2</sub>	ppb	< 10
	Cl <sub>2</sub>	ppb	< 1
	NO <sub>2</sub>	ppb	< 50
Group B	HF	ppb	< 1
	NH <sub>3</sub>	ppb	< 500
	O <sub>3</sub>	ppb	< 2
a: Part per billion (ppb) is the number of units of mass of a contaminant per billion units of total mass.			

Group A and group B are common gas groups in a data center. The concentration limits of group A or group B that correspond to copper reactivity level G1 are calculated based on the premise that relative humidity in the data center is lower than 50% and that the gases in the group interact with each other. A 10% of increase in the relative humidity will heighten the gaseous corrosivity level by 1.

Corrosion is not determined by a single factor, but by comprehensive environmental factors such as temperature, relative humidity, corrosive airborne contaminants, and ventilation. Any of the environmental factors may affect the gaseous corrosivity level. Therefore, the concentration limitation values specified in the previous table are for reference only.

## 7.5 Heat Dissipation and Noise

A storage system can run steadily using the heat dissipation system carried in its own fan modules. An external device is necessary to remove the hot air discharged from a storage system into the equipment room to ensure proper air circulation.

## Heat Dissipation

Traditional heat dissipation modes are as follows:

- **Controller enclosure**  
Cooling air enters from the front end through small holes on the interface modules. After dissipating the heat of interface modules, controllers, and power modules, the air is discharged out of its back end by fans. The controller enclosure dynamically adjusts rotational speed of the fans based on the operational temperature of the storage system.
- **Disk enclosure**  
Cooling air enters from the front end through the space between disks, passing the midplane, into the power modules and expansion modules. After dissipating the heat, the air is discharged out of its back end by fans. The disk enclosure dynamically adjusts rotational speed of the fans based on the operational temperature of the storage system.

For better maintenance, ventilation, and heat dissipation, pay attention to the following when installing the storage system in the cabinet:

- To ensure smooth ventilation, the cabinet should be at least 100 cm (39.4 inches) away from the equipment room walls and at least 120 cm (47.24 inches) away from other cabinets (that are in front of or behind).
- To keep air convection between the cabinet and the equipment room, no enclosed space is allowed in the cabinet. 1 U (44.45 mm or 1.75 inches) space should be left above and below each device.

The airflow parameters of the storage system are listed in [Table 7-7](#).

**Table 7-7** Airflow parameters of storage systems

Device	System Airflow
Controller enclosure	<ul style="list-style-type: none"> <li>● 75 CFM<sup>a</sup> (at max. fan speed)</li> <li>● 24 CFM (25°C)</li> </ul>
2 U disk enclosure	<ul style="list-style-type: none"> <li>● 117 CFM (at max. fan speed)</li> <li>● 38 CFM (25°C)</li> </ul>
4 U disk enclosure	<ul style="list-style-type: none"> <li>● 151 CFM (at max. fan speed)</li> <li>● 52 CFM (25°C)</li> </ul>
a: CFM, Cubic Feet per Minute	

The heat dissipation parameters of the storage system are listed in [Table 7-8](#).

**Table 7-8** Heat dissipation parameters of a storage system

Device	Maximum Heat Dissipation
Controller enclosure	12 disk slots: 1628 BTU <sup>3</sup> /h 25 disk slots: 1773 BTU/h



Device	Maximum Heat Dissipation
2 U disk enclosure	914 BTU/h
4 U disk enclosure	1610 BTU/h
a: BTU, British Thermal Unit.	

## Noise

The disks and fans make noise when in operation, with fans being the major noise source. The intensity of fan rotation is associated with the temperature. A higher temperature leads to greater rotational speed by the fans, which in return creates greater noise. Therefore, there is a direct correlation between the noise made by a storage system and the ambient temperature in the equipment room.

When the temperature is 25°C, the parameters of the noise generated by the storage system are listed in [Table 7-9](#).

**Table 7-9** Noise parameters of a storage system

Device	Noise Power
800 W power configured	61.3 dB (25°C)

# 8 Standards Compliance

The chapter describes the protocol standards, the safety specifications and electromagnetic compatibility (EMC) standards, and the industry standards that the storage system complies with.

## Protocol Standards

**Table 8-1** lists the protocol standards that the storage system complies with.

**Table 8-1** Protocol standards

Name	Standard No.
SCSI system	FC-PH: ANSI X3.230
	FC-PH2: ANSI X3.297
	SCSI-FCP: ANSI X.269
	FC-AL: ANSI X.272
	FC-AL-2: ANSI NCITS 332-1999
	FC-SW: ANSI NCITS 321
	FC-SW-2: ANSI NCITS 355-2001
	FC-GS: ANSI X.288 (for FC switch)
	FC-GS2: ANSI NCITS 288 (for FC switch)
	SAS Serial Attached SCSI-1.1 (SAS-1.1)
	SAS Serial Attached SCSI-2.0 (SAS-2.0)
	SAS Serial Attached SCSI-3.0 (SAS-3.0)
	T10/1562D Rev.05 Serial Attached SCSI (SAS)
	T10/1601D Rev.07 Serial Attached SCSI Model-1.1 (SAS-1.1)
	T10/1601D Rev.07 Serial Attached SCSI Model-1.1 (SAS-2.0)

Name	Standard No.
	T10/1601D Rev.07 Serial Attached SCSI Model-1.1 (SAS-3.0)
	SFF 8301 form factor of 3.5" disk drive
	SFF 8323 3.5" disk drive form factor with serial connector
	SFF 8482 SAS plug connector
	SCSI 3 SAM-2: ANSI INCITS 366-2003
	SPC-2: ANSI INCITS 351-2001
	SBC: ANSI INCITS 306-1998
	PICMG3.0 Advanced Telecommunications Computing Architecture
	PICMG3.1 Ethernet/Fibre Channel Over PICMG3.0
	iSCSI RFC 3720/7143
TCP/IP system	SNMP v1
	SNMP v2c
	SNMP v3
PCIe system	PCI Express Base Specification R1.1
	PCI Express to PCI or PCI-X Bridge Specification v1.0
	PCI Express Base Specification v2.0

## Safety Specifications and EMC Standards

**Table 8-2** lists the safety specifications and EMC standards that the storage system complies with.

**Table 8-2** Safety specifications and EMC standards

Name	Standard No.
China safety standard	GB 4943
North America safety standard	UL 60950-1
European safety directive	2014/35/EU
European safety standard	EN 60950-1
China EMC standard	GB9254-2008
	GB17625.1-2012
Canada EMC standard	ICES-003

Name	Standard No.
	CAN/CSA-CEI/IEC CISPR 22:02
North America EMC standard	FCC, CFR 47 Part 15, Subpart B
European EMC directive	EMC Directive 2004/108/EC
European EMC standard	EN 55032
	EN 55024

## Industry Standards

**Table 8-3** lists the industry standards that the storage system complies with.

**Table 8-3** Industry standards

Name	Standard No.
Ethernet	IEEE 802.3
Fast Ethernet	IEEE 802.3u
Gigabit Ethernet	IEEE 802.3z
	IEEE 802.3ab
10-Gigabit Ethernet	IEEE 802.3ae
VLAN	IEEE 802.1q
IEEE standard test access port and boundary-scan architecture	IEEE 1149.1-2001
Procedure for failure modes and effects analysis (FMEA)	IEC 812
Presentation of reliability, maintainability and availability predictions	IEC 863
ETSI standard (environment)	ETS 300 019
ETSI standard (power)	ETS 300 132
ETSI standard (noise)	ETS 300 753
ETSI standard (environment)	ETS 300 119
ETSI standard (grounding)	ETS 300 253

Name	Standard No.
ITUT standard (grounding)	ITUT K.27
Environmental protection	ECMA TR/70
Reliability	GR-929, Telcordia SR-332
Clean room and related controlled environments	ISO 14664-1 Class8
Airborne contaminants and environment standards	ANSI/ISA-71.04-1985 severity level G1

# 9 Certifications

The chapter describes the certifications of the storage system.

**Table 9-1** lists the certifications that the storage system obtains.

**Table 9-1** Certifications

Name	Description
CB	<p>The IEC System for Conformity Testing and Certification of Electrical Equipment (IECEE) is based on the use of specific IEC standards for electrical equipment. The Certification Bodies (CB) Scheme is applicable to electrical equipment within the scope of IEC standards for safety, accepted for use in the IECEE. The Scheme becomes operative for such standards as soon as at least one National Certification Body has declared their recognition of CB Test Certificates. The CB scheme is designed for eliminating the international commerce barriers resulted from the compliance with certifications and approval guidelines of different countries.</p> <p>The IEC System for Conformity Testing to Standards for Safety of Electrical Equipment (referred to as the IECEE) is based on the use of specific IEC standards for electrical equipment. The CB Scheme is applicable to electrical equipment within the scope of IEC standards for safety, accepted for use in the IECEE. The Scheme becomes operative for such standards as soon as at least one National Certification Body has declared their recognition of CB Test Certificates.</p>
CCC	<p>China Compulsory Certification (CCC) is a three-in-one authoritative certification incorporating the Conformity Certification of Electrical Equipment (CCEE), the certificate for the safe license of import granted by China Commodity Inspection Bureau (CCIB), and Safety and Electro Magnetic Compatibility (EMC).</p> <p>The China Compulsory Certificate (CCC) mainly involves the products related to human health and security, animal and plant life and health, environmental protection, and public security.</p>

Name	Description
FCC	Federal Communications Commission (FCC) authorizes and manages all RF transmission facilities and devices except for those used by the federal government. It is also responsible for the environmental damages generated by the facilities and devices it approves.
IC	Industry Canada (IC) sets up the test standards for analog and digital terminal devices and specifies corresponding EMC certificates that all import electronic products must obtain.
UL	<p>Underwriters Laboratories Inc. (UL): The UL is a non-profit agency engaged in product safety testing.</p> <p>UL has its own certification system for the entire system, components, and materials. All electric products that are exported to the USA must pass the UL certification.</p> <p>The UL safety certification is classified into the following three methods:</p> <ul style="list-style-type: none"> <li>● <b>Labeling</b> The UL labeling service is the best known service of the UL safety certification. The UL label on the product indicates that UL has tested the sample of the product according to the safety standards approved by the USA. The sample does not cause fire, creepage, or other dangers if predictable.</li> <li>● <b>Classification</b> UL tests the product according to different features, in the specified danger range, or under specific cases. In general, the classified products are mostly construction materials or industrial instruments. The classified products include industrial or commercial products. Some specified features must be tested, such as inflammability, hazardous performance, or specifications specified by the government.</li> <li>● <b>Approval</b> UL tests parts of the product or unfinished product. These parts will be used in the UL labeled product list. This service covers millions of plastics, wires, circuit boards, various finished products, and even some large components, such as motorcycles or power supplies.</li> </ul>
CE	<p>Conformite Europeenne (CE): Products marked with CE conform to EMC (2014/30/EU) and low-voltage (2014/35/EU) specifications published by EU.</p> <p>If this product has telecommunication functionality, the R_TTE Directive (1999/5/EC) that complies with the directives mentioned previously implies conformity to the following European norms (in parentheses are the equivalent international standards and regulations):</p> <ul style="list-style-type: none"> <li>● EN 55032 (CISPR 32)-Electro Magnetic Interference</li> <li>● EN 55024 (IEC61000-4-2, 3, 4, 5, 6, 8, 11)-Electro Magnetic Immunity</li> <li>● EN 60950 (IEC 60950)-Product Safety</li> </ul>
REACH	REACH is a set of comprehensive regulations that require all chemical products that are both imported and produced in Europe must be registered, assessed, authorized, and restricted. In this way, customers can easily recognize the chemical elements. As a result, both humans and environment are protected.

Name	Description
RoHS	<p>The restriction of the use of certain hazardous substances in electrical and electronic equipment (RoHS) is the directive that restricts the use of certain hazardous substances in the electrical, electronic equipment.</p> <p>RoHS is the European Union (EU) compulsory standard that is designed to regulate the materials and the technical standard of the electrical and electronic products. In this way, it does good to human health and environment protection. That is, the six hazardous substances of lead (Pb), mercury (Hg), cadmium (Cd), hexavalent chromium (Cr6+), polybrominated biphenyl (PBB), polybrominated diphenyl ethers (PBDE) cannot exceed the specified limits.</p>
WEEE	<p>The EU Directive on Waste of Electric and Electronic Equipment. Electrical and electronic products sold in the EU market must comply with this directive and have the mark of cross out wheeled bin.</p>
CU-TR	<p>Russia, Kazakhstan, and Belarus have integrated their own certification technology requirements and formulated a unified Customs Union (CU) certification. The products within the scope of control are subject to mandatory certification of customs union technical regulations (CU-TR), unified technical regulations and evaluation modes, product qualification directories, certificate forms, and technical supervision and registration.</p>
RCM	<p>The Australian &amp; New Zealand Regulatory Compliance Mark (RCM) is the mandatory compliance for selling electrical equipment products in the market.</p>
SONCAP	<p>A certification issued by Standards Organization of Nigeria. The products in the certification item list must acquire SONCAP for the entrance to Nigeria market.</p>

## Security Symbol (CCC)

The product is a Class A device based on the CCC. Use of it in a residential area is likely to cause radio interference. Users may be required to prevent the interference by taking protective measures.



## FCC-DOC

**Supplier's Declaration of Conformity (SDoC)**

**Unique Identifier:** trade name: HUAWEI; product name: Storage System; model number: OceanStor 2200 V3

**Responsible Party- U.S. Contact Information**

Huawei Technologies USA Inc.

5700 Tennyson Parkway, Suite 500

Plano, Texas 75024

Main: 214-919-6000 / TAC Hotline: 877-448-2934

**FCC Compliance Statement (for products subject to Part 15)**

This device complies with part 15 of the FCC Rules. Operation is subject to the following two conditions: (1) This device may not cause harmful interference, and (2) this device must accept any interference received, including interference that may cause undesired operation.

# 10 Operation and Maintenance

The storage systems can be operated and maintained by using DeviceManager and the command-line interface (CLI), adapting to different environments and user habits.

## Introduction to DeviceManager

Figure 10-1 shows the DeviceManager main window.

Figure 10-1 DeviceManager main window

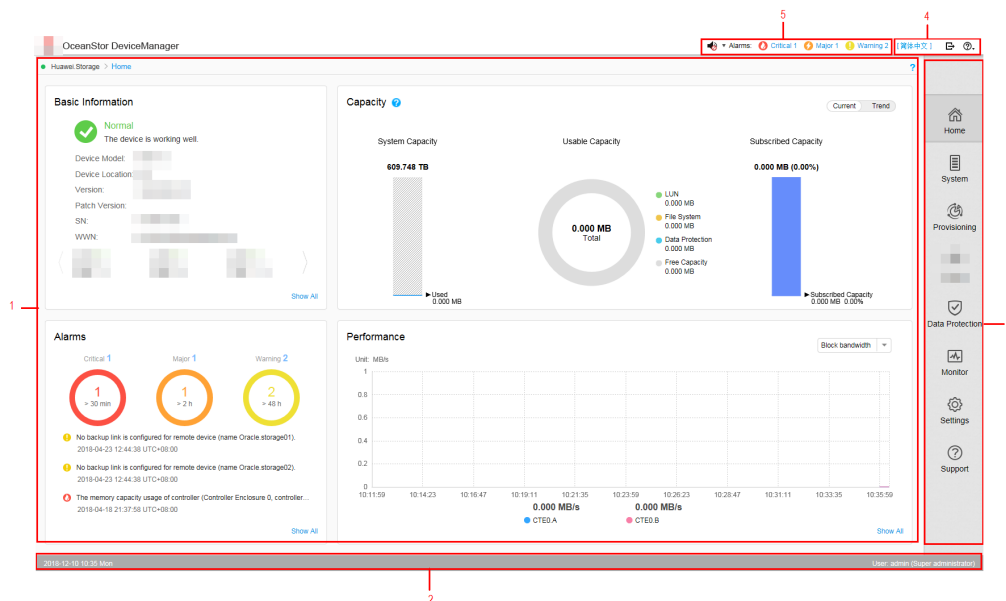

Table 10-1 describes the components of the DeviceManager main window.

Table 10-1 Components of the DeviceManager main window

No.	Name	Description
1	Function pane	The function pane shows a page associated with the current operation.

No.	Name	Description
2	Status bar	The status bar shows information such as the user name currently logged in and the login time.
3	Navigation bar	The navigation bar shows the function modules of a storage system. Users can click a function module to configure the corresponding functions.
4	Exit, help, and language selection area	This area displays an exit button, a help button, and a language selection button. DeviceManager supports two languages: simplified Chinese and English.
5	Fault statistics area	The fault statistics area shows the number of each level of system faults, helping users better understand the running status of a storage system.

Users can log in to DeviceManager using a common browser.

To master GUI-based operations, you are advised to read this document and practice the operations using the DeviceManager Demo. As a simulation program of storage system management software, the DeviceManager Demo simulates configuration and management operations on a storage system.

## Introduction to the CLI

The CLI enables users to manage and maintain the V3 series storage systems using command lines.

Users need to log in to the CLI by using terminal software, such as the HyperTerminal provided by Windows, or PuTTY.

There are two ways to log in to the CLI.

- Log in through a serial port of a storage system. To connect to a serial port, the maintenance terminal must be located next to the storage system. Therefore, this login mode is applicable to the scenario where a user does not know the management IP address of a storage system or a storage system is faulty.
- Log in through a management network port of a storage system. When there are reachable routes, a user can log in to the CLI by entering the IP address of the management network port of a storage system in the terminal software. IP networks are easily accessible. Therefore, a user can log in to a storage system remotely, and this login mode is more popular.

---

# A How to Obtain Help

---

If a tough or critical problem persists in routine maintenance or troubleshooting, contact Huawei for technical support.

## A.1 Preparations for Contacting Huawei

To better solve the problem, you need to collect troubleshooting information and make debugging preparations before contacting Huawei.

### A.1.1 Collecting Troubleshooting Information

You need to collect troubleshooting information before troubleshooting.

You need to collect the following information:

- Name and address of the customer
- Contact person and telephone number
- Time when the fault occurred
- Description of the fault phenomena
- Device type and software version
- Measures taken after the fault occurs and the related results
- Troubleshooting level and required solution deadline

### A.1.2 Making Debugging Preparations

When you contact Huawei for help, the technical support engineer of Huawei might assist you to do certain operations to collect information about the fault or rectify the fault directly.

Before contacting Huawei for help, you need to prepare the boards, port modules, screwdrivers, screws, cables for serial ports, network cables, and other required materials.

## A.2 How to Use the Document

Huawei provides guide documents shipped with the device. The guide documents can be used to handle the common problems occurring in daily maintenance or troubleshooting.

To better solve the problems, use the documents before you contact Huawei for technical support.

## A.3 How to Obtain Help from Website

Huawei provides users with timely and efficient technical support through the regional offices, secondary technical support system, telephone technical support, remote technical support, and onsite technical support.

Contents of the Huawei technical support system are as follows:

- Huawei headquarters technical support department
- Regional office technical support center
- Customer service center
- Technical support website: <http://support.huawei.com/enterprise/>

You can query how to contact the regional offices at <http://support.huawei.com/enterprise/>.

## A.4 Ways to Contact Huawei

Huawei Technologies Co., Ltd. provides customers with comprehensive technical support and service. For any assistance, contact our local office or company headquarters.

Huawei Technologies Co., Ltd.

Address: Huawei Industrial Base Bantian, Longgang Shenzhen 518129 People's Republic of China

Website: <http://enterprise.huawei.com/>

# B Glossary

---

If you want to obtain information about glossaries, visit <http://support.huawei.com/enterprise/>. In the search field, enter a product model, and select a path from the paths that are automatically displayed to go to the document page of the product. Browse or download the *OceanStor V3 Series V300R006 Glossary*.

---

# C Acronyms and Abbreviations

---

## A

**ANSI** American National Standards Institute

## B

**BBU** Backup Battery Unit

## C

**CLI** Command Line Interface

## E

**ESN** Equipment Serial Number

## F

**FC** Fibre Channel

**FC-AL** Fibre Channel Arbitrated Loop

**FCoE** Fibre Channel over Ethernet

## G

**GE** Gigabit Ethernet

**GUI** Graphical User Interface

## H

**HBA** Host Bus Adapter

**HD** High Density

## I

**IP** Internet Protocol

---

<b>ISA</b>	Instrument Society of America
<b>iSCSI</b>	Internet Small Computer Systems Interface
<b>ISO</b>	International Organization for Standardization
<b>L</b>	
<b>LUN</b>	Logical Unit Number
<b>M</b>	
<b>MTBF</b>	Mean Time Between Failures
<b>MTTR</b>	Mean Time to Repair
<b>N</b>	
<b>NL-SAS</b>	Near Line Serial Attached SCSI
<b>P</b>	
<b>PDU</b>	Power Distribution Unit
<b>U</b>	
<b>USB</b>	Universal Serial Bus
<b>R</b>	
<b>RAID</b>	Redundant Array of Independent Disks
<b>RSCN</b>	Registered State Change Notification
<b>S</b>	
<b>SAN</b>	Storage Area Network
<b>SAS</b>	Serial Attached SCSI
<b>SCSI</b>	Small Computer System Interface
<b>SSD</b>	Solid State Drive
<b>V</b>	
<b>VLAN</b>	Virtual Local Area Network
<b>VPN</b>	Virtual Private Network